

**CROPLANDS**

# GENERAL SPRAYER OPERATION

[WWW.CROPLANDS.COM.AU](http://WWW.CROPLANDS.COM.AU)

**STOP**

**BEFORE COMMENCING**  
operation, **ENSURE** you read  
& understand this manual, its  
contents, and any additional  
information supplied.



GP-POM001108 | Update 1 FSC



CROPLANDS IS CONTRIBUTING TO A SUSTAINABLE FUTURE

# INTRODUCTION

## GENERAL MANAGER'S WELCOME



**Sean Mulvaney**  
**General Manager**

Dear Customer

Congratulations on the purchase of your new sprayer and thank you for supporting another true blue Australasian manufacturer. For over 50 years Croplands have been delivering spraying solutions and ongoing support for a variety of applications whilst investing in long term partnerships with our suppliers, distributors, end users and local communities. These partnerships are absolutely key in our commitment to support our products into the future.

At Croplands, we are committed to sourcing the very best technology from around the globe and adapting these products to our specific requirements. When these products don't yet exist, we innovate through continuous investment in our own research and development.

Croplands is a wholly owned subsidiary of Nufarm Ltd, the largest supplier of crop protection products in Australasia. This brings a unique understanding and collaborative approach to new market developments, challenges and opportunities.

Please take the time to thoroughly read this manual before you operate your sprayer. This will provide direction to ensure safe usage and help optimise the performance of your investment. Your feedback is welcome and valued.

We trust you will be happy with your sprayer and the level of support - our goal is to be your preferred spraying solutions partner from this point onwards.

Yours Sincerely

**Sean Mulvaney**  
**General Manager**

Croplands has taken steps to ensure this operator's manual is as current and as accurate as possible. Due to the ever-changing markets of cropping and farming, Croplands is constantly striving to be at the forefront of innovation and technology. While the information in this manual is considered accurate at the time of writing, Croplands reserves the right to change this information without notice. Croplands will not accept liability for any inaccuracy in this publication, or changes forthwith.



# CONTENTS

## NOTE

This GENERAL manual is a generic overview to a variety of spray operations. It contains information relating to Broadacre and/or Horticulture operations. Some features and options explained in this manual may not be installed on your sprayer.

### SECTION 1 IMPORTANT INFORMATION

|                               |   |
|-------------------------------|---|
| About this manual             | 4 |
| Terminology                   | 4 |
| Before Operating Your Sprayer | 4 |
| Warranty Policy               | 5 |

### SECTION 2 SAFETY

|                         |   |
|-------------------------|---|
| Safety first            | 6 |
| Safety signs and decals | 7 |

### SECTION 3 PRODUCT IDENTIFICATION, SHIPPING & SPECIFICATION

|                        |   |
|------------------------|---|
| Product identification | 8 |
| Shipping information   | 8 |
| Weights & dimensions   | 8 |

### SECTION 4 PRE-OPERATION

|                         |    |
|-------------------------|----|
| Hook up                 | 10 |
| Pre-operation checklist | 15 |

### SECTION 5 SPRAYER OPERATIONS

|                           |    |
|---------------------------|----|
| Filling the tanks         | 18 |
| Filter maintenance        | 20 |
| Quantum pointers          | 21 |
| Tank & equipment cleaning | 22 |

### SECTION 6B SPRAYING INFORMATION - BROADACRE

|                                   |    |
|-----------------------------------|----|
| Calibration procedure             | 24 |
| Air-mix & TURBODROP® nozzle chart | 31 |
| Calibration worksheet             | 34 |

### SECTION 6H SPRAYING INFORMATION - HORTICULTURE

|  |    |
|--|----|
| Spraywise  | 36 |
| Calibration  | 36 |
| Flowmeter calibration                                    | 37 |
| Step 1 - Ensure equipment is in good working order       | 37 |
| Step 2 - Determining the actual speed of travel          | 39 |
| Step 3 - Determine spraying volume required              | 39 |
| Step 4 - Determine sprayer configuration                 | 39 |
| Step 5 - Determine the ideal spray pressure              | 40 |
| Step 6 - Determine & select correct nozzles              | 40 |
| Step 7 - Fit & test selected nozzles                     | 41 |
| Step 8 - Calculate the actual application rate           | 41 |
| Step 9 - If the tested rate is unsatisfactory            | 42 |
| Step 10 - Coverage assessment                            | 43 |
| Step 11 - Add the correct amount of chemical to the tank | 43 |
| Step 12 - Record all data for future reference           | 44 |
| Calibration worksheet                                    | 45 |

### SECTION 7 LUBRICATION & MAINTENANCE

|                                   |    |
|-----------------------------------|----|
| Greasing & Service Procedures     | 47 |
| Grease Point Diagrams             | 48 |
| Pumps                             | 49 |
| Diaphragms, Straps & Foam Markers | 50 |

### SECTION 8 TROUBLESHOOTING

|                               |    |
|-------------------------------|----|
| Diaphragm Pump Problems       | 54 |
| General Sprayer Problems      | 56 |
| Hydraulic Pump Drive Problems | 57 |
| Foam Marker Problems          | 58 |

### SECTION 9 ASSEMBLY DRAWINGS, PARTS & SCHEMATICS 59

# SECTION 1

## IMPORTANT INFORMATION

### ABOUT THIS MANUAL

This GENERAL manual is a generic overview for setting up, operating and maintaining your Croplands sprayer for which there is not a specific manual.

In addition to this manual, the sprayer will be delivered with the General Safety Manual (GP-SAFE-A).

For details not covered by the manuals, please contact Technical Support on 1300 650 724.

Some features and options explained in this manual may not be installed on your sprayer.

Please pass on this manual with the sprayer at the time of resale for usage by the new owner.

This manual, was first published in 2008 as part number, GP-POM001108. The April 2021 issue updates sections 6B and 6H. November 2023 = FSC Update.

**Check online** as there may be more recent revisions of this manual. [www.croplands.com.au](http://www.croplands.com.au)

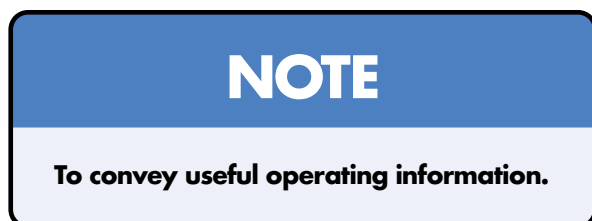

### TERMINOLOGY

These terms/symbols used throughout this manual:

|                |   |
|----------------|---|
| <b>NOTE</b>    | This Note sign is in place to convey useful information and will help you to identify the best possible way to operate the machine.   |
| <b>CAUTION</b> | This Caution sign shows the potential for incident. An incident may include damage to the machine itself, or possible injury to the operator.                                   |
| <b>WARNING</b> | This warning sign shows the potential for risk or injury and highlights the need for steps to be taken to protect ones safety.  |
| <b>DANGER</b>  | This Danger sign will be used in areas where the highest risk is present. Always read the information on these signs and ensure you are taking steps to prevent risk or injury. |



### BEFORE OPERATING YOUR SPRAYER

1. Before attempting to use your sprayer, make sure you read all Operator Manuals for this sprayer including but not limited to:

This Operator's Manual, **and all other supplied manuals** for items such as controller, pump and PTO etc.



And properly understand:

- All Safety Issues.
- Assembly & Installation instructions.
- Calibration of the sprayer.
- Sprayer Operation.
- Sprayer Maintenance.

For details not covered by the manuals, please contact Technical Support on 1300 650 724.

2. Read and follow instructions on chemical manufacturers' labels.
3. Always wear applicable protective clothing.

### INTENDED USE

Croplands sprayers are designed to be used for multipurpose spraying of herbicides, pesticides and fertilisers. The sprayer must not be used for any other purpose.

# SECTION 1

## IMPORTANT INFORMATION

### WARRANTY POLICY

Each sprayer module will be delivered with a Specifications, Safety, Warranty & Delivery Booklet which includes:

- the sprayer's specification sheet including the sprayer's unique serial number,
- a safety induction checklist,
- a delivery checklist and customer induction,
- the Croplands Warranty policy and warranty registration form.

**We ask that our customers complete these forms in the presence of a Dealer and/or Croplands representative as a part of the sprayer's delivery process.**

Always contact your Croplands Dealer first and foremost for warranty matters.

### NOTE

**For full conditions of warranty and warranty policy, please see the Specification, Safety, Warranty & Delivery booklet provided with this sprayer.**

**SPRAYER SPECIFICATIONS  
SAFETY, WARRANTY & DELIVERY  
BROADACRE**

WWW.CROPLANDS.COM.AU

**STOP**  
BEFORE COMMENCING  
operation. ENSURE you read  
& understand this manual, its  
contents, and any additional  
information supplied.

GP-WAB-S

INCLUDES SAFETY INDUCTION

CROPLANDS IS CONTRIBUTING TO A SUSTAINABLE FUTURE

**WARRANTY & PRE-DELIVERY  
UTILITY  
SPRAYERS**

WWW.CROPLANDS.COM.AU

**STOP**  
BEFORE COMMENCING  
operation. ENSURE you read  
& understand this manual, its  
contents, and any additional  
information supplied.

GP-WAR-A

CROPLANDS IS CONTRIBUTING TO A SUSTAINABLE FUTURE

**SPRAYER SPECIFICATIONS  
SAFETY, WARRANTY & DELIVERY  
HORTICULTURE**

WWW.CROPLANDS.COM.AU

**STOP**  
BEFORE COMMENCING  
operation. ENSURE you read  
& understand this manual, its  
contents, and any additional  
information supplied.

GP-WAH-S

INCLUDES SAFETY INDUCTION

CROPLANDS IS CONTRIBUTING TO A SUSTAINABLE FUTURE

**SPRAYER SPECIFICATIONS  
WARRANTY & PRE-DELIVERY  
LINKAGE**

WWW.CROPLANDS.COM.AU

**STOP**  
BEFORE COMMENCING  
operation. ENSURE you read  
& understand this manual, its  
contents, and any additional  
information supplied.

GP-WAL-A

CROPLANDS IS CONTRIBUTING TO A SUSTAINABLE FUTURE

# SECTION 2

## SAFETY

### SAFETY FIRST

Please read and understand all supplied manuals, guides and safety decals before operating this sprayer. This includes the **Croplands Operators Safety Manual** – as pictured here.

This manual is available on the Croplands Web site, or for printed versions contact Croplands customer support and ask for part number GP-SAFE-A (or later version if available).



# SECTION 2

## SAFETY

### SAFETY SIGNS AND DECALS

All signs and decals for sprayer safety and operation must be maintained in good order and replaced if damaged or missing. Most Croplands labels have a part number printed on the decal to aid identification and replacement.

Some examples are shown below.

**WARNING**

**SAFETY INSTRUCTIONS**

1. Read your operators manual thoroughly before operating the sprayer.
2. Inspect hoses, connections and nozzles daily.
3. Clean filters regularly.
4. Always follow correct maintenance schedules outlined in operator's manuals.
5. Always read chemical manufacturers labels before use.
6. Always observe all warnings on chemical products.
7. Regularly check all nuts and bolts are tight.
8. Always wear rubber gloves and wash sprayer down before doing any repair or maintenance work.
9. Do not ride on sprayer when moving.
10. Keep clear of moving parts when sprayer is operating.
11. Always keep guards in place when sprayer is operating.
12. Be sure tank lid is closed before operating basket mixing facility.
13. Stand well clear of sprayer when operating.
14. Do not disconnect hoses, nozzles or filters while sprayer is operating.

**FAILURE TO FOLLOW THE ABOVE INSTRUCTIONS MAY RESULT IN SERIOUS INJURY OR DEATH.**

Part No: XD - 123

**WARNING**

**OPERATION INSTRUCTIONS**

FOR SAFETY PROCEDURES READ THE OPERATORS MANUAL.

STOP THE ENGINE AND REMOVE THE IGNITION KEY BEFORE (AND AFTER) WORKING ON THE MACHINE.

DO NOT START THE MACHINE WITHOUT ENSURING ALL PEOPLE ARE WELL CLEAR OF WORKING PARTS. SOUND THE HORN BEFORE START UP

FAILURE TO OPERATE CORRECTLY MAY RESULT IN SERIOUS INJURY OR DEATH!

Part No: XD - 125V

**WARNING**

DO NOT FILL THE TANK IN EXCESS OF THE CARRYING CAPACITY OF THE VEHICLE WITH WHICH THE TANK WILL BE USED, AS SPECIFIED BY THE VEHICLE MANUFACTURER.

1 Litre of water = 1 Kg    50 Litres of water = 50 Kg

DO NOT EXCEED THE VEHICLE MANUFACTURERS SPECIFIED SAFE LOAD CARRYING AND TOWING CAPACITIES.

READ THE OPERATORS INSTRUCTION MANUAL AND CHECK UNLADEN WEIGHT BEFORE ATTACHING OR USING THIS PRODUCT.

Part No: XD - 126V

**WARNING**

Never operate your sprayer with a loose rim, wheel or axle.

**ENSURE ALL WHEEL NUTS ARE TIGHT BEFORE USE.**

Anytime wheel nuts are loosened, retighten to specified torque.

Failure to do so may result in a serious accident.

**CROPLANDS**

Part No: XD - 175

**WARNING**

**BEWARE OF MOVING PARTS.**

Failure to operate correctly may result in serious injury or death!

**CROPLANDS**

Part No: XD - 182

**WARNING**

THIS IS A SPECIAL PURPOSE MACHINE AND IS NOT DESIGNED FOR PROLONGED HIGHWAY USE AT SPEEDS EXCEEDING 25 KPH.

Failure to operate correctly may result in serious injury or death!

Always drive to the conditions.

In some cases 25 kph will be excessive.

**CROPLANDS**

Part No: XD - 176

**CAUTION**

**WATER ONLY**

DO NOT ADD CHEMICAL

Part No: XD - 127V

**CAUTION**

**WATER FOR OPERATOR WASHING ONLY**

DO NOT DRINK

Part No: XD - 124V

**DANGER**

ENTANGLEMENT IN PTO SHAFT CAN SERIOUSLY INJURE OR KILL

- DO NOT EXCEED PTO OPERATING SPEED OF 540 RPM.
- ENSURE ALL SAFETY GUARDS ARE IN PLACE.
- GREASE SLIDING SHAFTS OF PTO DAILY.
- EXCESSIVE VIBRATION MAY OCCUR IF USING PTO SPEEDS LESS THAN 300 RPM WHEN FILLING.

**CROPLANDS EQUIPMENT PTY LTD**

Part No: XD-122V

**DANGER**

THERE IS A RISK OF ROLLOVER WHEN OPERATING ON SLOPES

- Slow down for slopes exceeding 10°
- Do not operate on slopes exceeding 15°
- Slow down when operating on irregular surfaces

FAILURE TO COMPLY WITH THESE PRECAUTIONS MAY RESULT IN DEATH OR INJURY

**CROPLANDS EQUIPMENT PTY LTD**

Part No: XD-194

**DANGER**

KEEP BODY PARTS AND LOOSE OBJECTS AWAY FROM ROTATING FAN

Failure to do so may result in serious injury.

**CROPLANDS EQUIPMENT PTY LTD**

Part No: XD - 195

**DANGER**

KEEP CLEAR OF POWERLINES WHILE OPERATING SPRAYER.

Never use the folding/unfolding functions near areas with overhead power lines.

**CROPLANDS EQUIPMENT PTY LTD**

Part No: XD - 181

# SECTION 3

## PRODUCT IDENTIFICATION, SHIPPING & SPECIFICATION

### PRODUCT IDENTIFICATION

Always use the serial number of the Sprayer when requesting service information or when ordering parts.

Early or later models (identification made by serial number) may use different parts, or it may be necessary to use a different procedure for specific service operations.

The serial numbers of all controllers, pumps etc should also be recorded for future reference.



Photo 1

### SHIPPING INFORMATION

All provided tie down points (and more) should be used to help secure the sprayer for transporting.

Note serial number plate in the attached image.



Photo 2



### WEIGHTS & DIMENSIONS

Croplands customer service can provide weights and dimensions details as required.

Freecall 1800 999 162

### TRACTOR REQUIREMENTS

Tractor size / power required is dependent upon a combination of tractor weight, sprayer weight (with full tanks), boom size, farm conditions (soil and terrain) and road (or inter-farm) travel requirements.

As a general rule, under ideal conditions, the gross sprayer weight should not exceed 150% of the gross tractor weight and the tractor front axle weight should not be less than 20% of gross tractor weight ... (refer New Zealand Agricultural Vehicles Guide 2017).

**Determining the correct tractor should be done in consultation with the tractor dealer.**



# SECTION 4

## PRE-OPERATION

### NOTE

This GENERAL manual is a generic overview to a variety of spray operations. It contains information relating to Broadacre and/or Horticulture operations. Some features and options explained in this manual may not be installed on your sprayer.

|                            |           |
|----------------------------|-----------|
| <b>HOOK-UP</b>             | <b>11</b> |
| <b>PRE-OPERATION CHECK</b> | <b>16</b> |

# SECTION 4

## PRE-OPERATION

### HOOK UP

#### Assembly Instructions

Your Sprayer is supplied fully assembled with up to six items requiring assembly after shipping from the factory:

1. Adjustments to the hitch and PTO may be necessary to match tractor drawbar & PTO requirements.  
For 3 point linkage, adjust the tractor arms as required.
2. Connect the hitch and PTO shaft to the tractor.
3. Connect any hydraulic hoses to the tractor &/or electric in-cab control for wing-lift (optional).
4. Connect and fit the Controller, if necessary.
5. Connect and fit the Foam Marker Controller (optional) to the Tractor.
6. Connect hydraulic pump drive hoses & adjust (if fitted as an option for centrifugal or diaphragm pumps).



Linkage sprayer with linkage style hitch

#### 1. Connecting a Trailed Sprayer & PTO Shaft to the Tractor

Your Croplands Sprayer must be connected to a suitable tractor, making sure the drawbar hitch and PTO shaft are fitted according to the instructions that follow:

1. Align drawbars of the tractor and sprayer, insert and lock drawbar pin in position ensuring the drawbar pin cannot come out while transporting or operating.
2. Remove the jack supporting the sprayer chassis, and store it on the frame lug provided.
3. Check the machine is level fore and aft. The sprayer should be slightly lower at the front. If not adjust the sprayer drawbars and axle to achieve level position.

### NOTE

**Be careful not to damage or deform the mesh or gasket while cleaning and refitting the filters and nozzle caps.**



Trailed sprayer with stand hitch

Follow the instructions below to fit the PTO shaft onto the your Sprayer after transit:

1. Remove the PTO shaft which is strapped to the sprayer frame.
2. Check the PTO shaft has not been damaged in transit.
3. Measure and fit the PTO to the sprayer ensuring the locking pin is correctly located. Make sure you read and understand "The important factors for fitting the PTO shaft" on the next page.
4. Grease the universal joints and telescoping shafts.
5. Fit the PTO to the machines ensuring the locking pin is correctly located.
6. Before operating the drive shaft, be sure that all safety guards and chains are in place.



Connect the PTO shaft to the machines

### NOTE

**Incorrect hitching of PTO shaft will result in excessive pump vibration and damage to the pump.**

# SECTION 4

## PRE-OPERATION

### Self-Tracking Drawbar

If your sprayer is fitted with a self-tracking drawbar, ensure the pivot points are greased regularly (every spray-round).

With the pump mounted on the top of the self-tracking drawbar, the PTO shaft will remain unchanged in length & direction during turning.

Ensure the drawbar is cut to the correct length for your tractor prior to operation & that the PTO shaft is greased every 4 hours during operation.

See your dealer about cutting the PTO to the correct length.

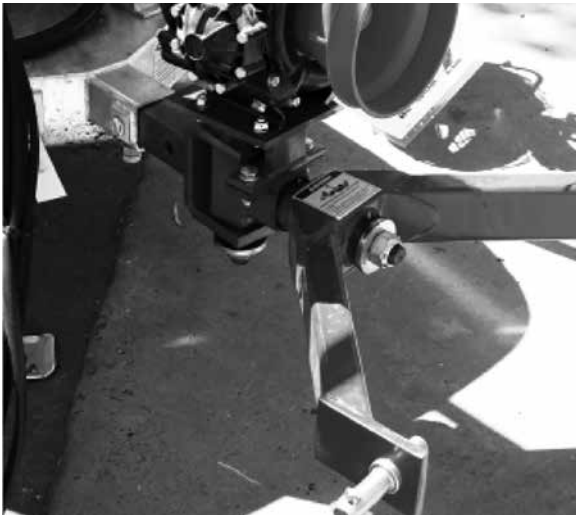

Optional self-tracking drawbar.

**WARNING**

**Moving the axle forward increases the weight at the rear of the machine. This can cause machine instability - causing the machine to tip backwards when disconnected from the tractor.**

### 2. Linkage Hitching

Most Croplands linkage sprayers are equipped to fit tractors with Category I, II or III linkages.

Models 500 & 700 litre have Cat II for the lower linkage arms, and Cat I for the top link with sleeve if your tractor has Cat II.

The 1000 litre linkage sprayer has a clevistype Cat III hitch for the lower arms and Cat II for the top link.

The 1200 litre has Cat III pins on the lower linkage & Cat II on the upper linkage point.

Your Croplands Sprayer must be connected to a suitable tractor, making sure the drawbar hitch and PTO shaft are fitted according to the instructions that follow:



Remove the PTO shaft from the sprayer.

1. Remove the PTO shaft from the sprayer by depressing the locking pin.
2. Lower the tractor linkage and attach it to the sprayer's lower hitch pins of the appropriate category, then connect the upper linkage arm using the tractor's linkage pin.
3. Secure all linkage pins with the lynch pins.
4. Raise the tractor linkage to the desired spraying height and level the sprayer by adjusting the length of the top linkage arm.



Raise and lower the sprayer to check that the telescopic tubes of the PTO overlap by approximately 1/3rd of their length, and not less than 150mm, in all operating positions.

5. Clean and grease the splines on the tractor and sprayer PTO stub shafts and install the PTO shaft making sure that the spring loaded locking pins engage in the interference grooves of both stub shafts.
6. Ensure that the PTO shaft guards and safety chains are attached to the sprayer and tractor.

# SECTION 4

## PRE-OPERATION

### NOTE

Upon delivery of a new PTO driven sprayer, it is the selling dealer's responsibility to install and set the PTO driveshaft to the correct length, as part of the installation service. The following/above information is provided for reference.

#### PTO Shaft Length

1. Set the linkage height so that the ends of the two shafts are at their closest distance.
2. Install the PTO shaft making sure that there is at least 25mm of telescopic travel remaining between the male and female sections.
3. Raise and lower the sprayer to check that the telescopic tubes of the PTO overlap by approximately 1/3rd of their length, and not less than 150mm, in all operating positions.

If the PTO shaft must be shortened, cut equal amounts from both male and female shafts and safety covers.

Carefully remove all burrs, swath them clean and re-lubricate before reassembling.

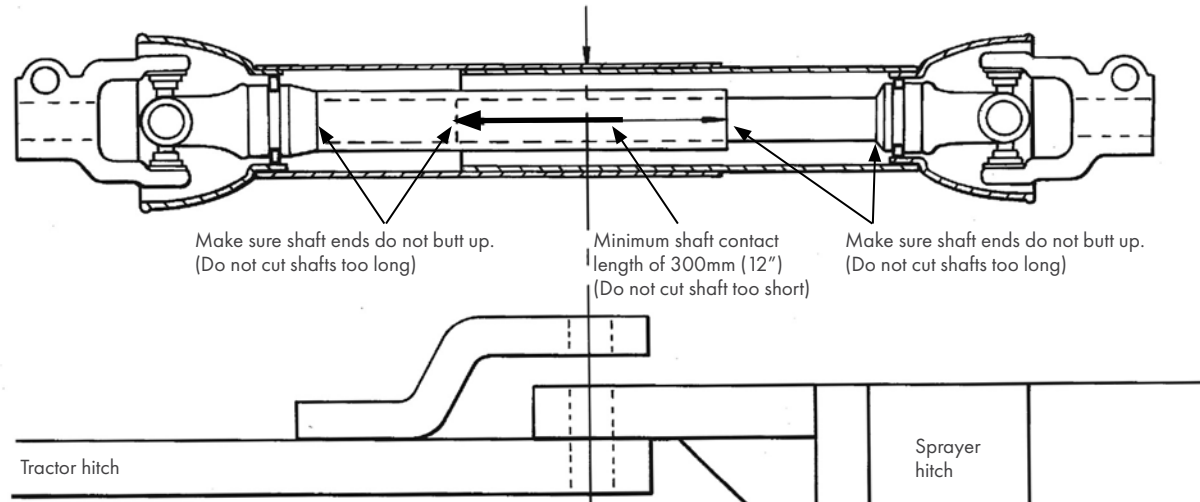

#### Important Factors when Fitting the PTO Shaft

The following three factors must be correct to avoid pump damage and maximise PTO operating life:

1. When travelling straight ahead, the point at which the sprayer drawbar pin is joined to the tractor should be as close as possible to centre between the universal joints of a Standard PTO shaft, as illustrated. The tractor is then able to make maximum turns with minimal bending of the universals.

2. When the tractor is towing the sprayer straight ahead, the two telescopic sections of the power take-off shaft are at maximum extension.

When turning or crossing an inversion, the telescopic shaft sections close up.



**Ensure that the drive shaft is the correct length to avoid any "butt up" damage to the pump.**

### NOTE

**IMPORTANT: Do not allow more than 10% difference in the two halves of drawbar length. If more than 10% difference occurs, a wide angle shaft must be used.**

# SECTION 4

## PRE-OPERATION

- The height difference between the tractor PTO spline and the PTO spline of the machine should not be more than 100mm.

This ensures PTO joint angles are approx equal and do not exceed limits. If greater than 100mm, a wide angle (constant velocity) PTO should be used.

**WARNING**  
 Maximum PTO speed for Croplands diaphragm pumps is 540 RPM.

**CAUTION**  
 Pump warranty is not valid for damage caused by incorrect PTO shaft mounting.

### Heed the Operating Limits of the Standard PTO Shaft

The standard sprayer is fitted with a STANDARD PTO shaft. The maximum intermittent turning angles of the Standard PTO shaft is only recommended where should not exceed 45° turning angle of the PTO.

### Standard PTO

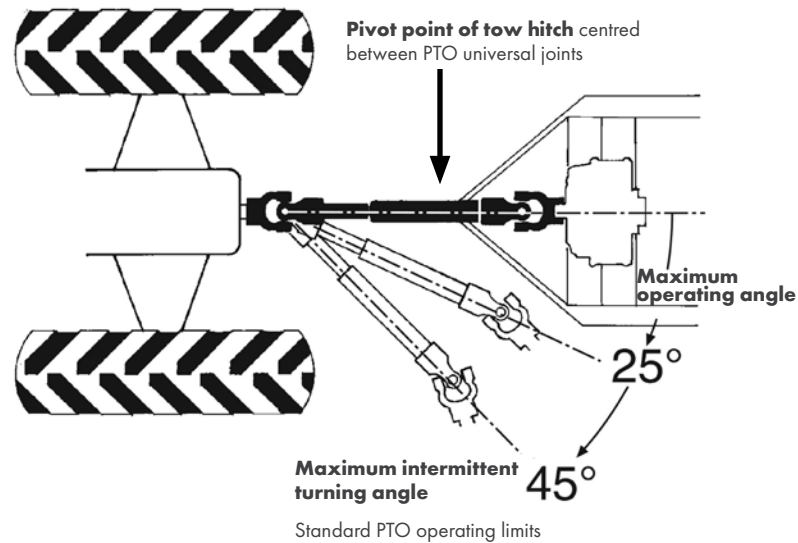

### Standard PTO Operating Limits

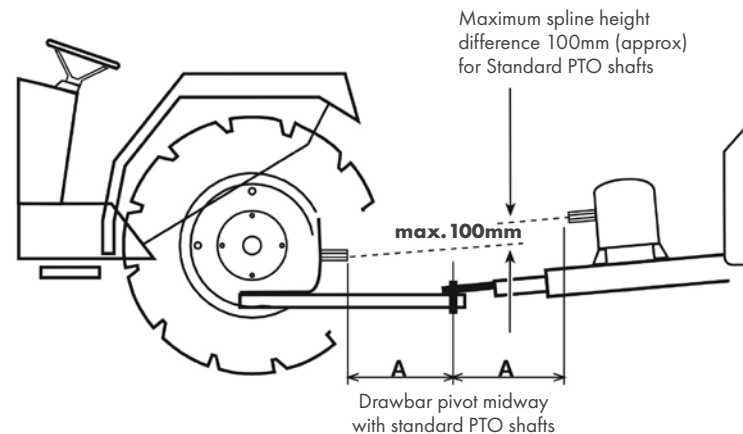

### 3. Connect Hydraulic Hoses to the Tractor

#### Boom Fold and Lift

If a standard hydraulic boom is fitted, the boom will provide simultaneous unfolding of boom sections and hydraulic lift adjustment of boom height.

Prior to connecting your boom hydraulic hoses, remove the boom lock-plate (see below). This plate is in place for transport to your dealer from the Croplands' factory.



Remove the boom lock-plate

# SECTION 4

## PRE-OPERATION

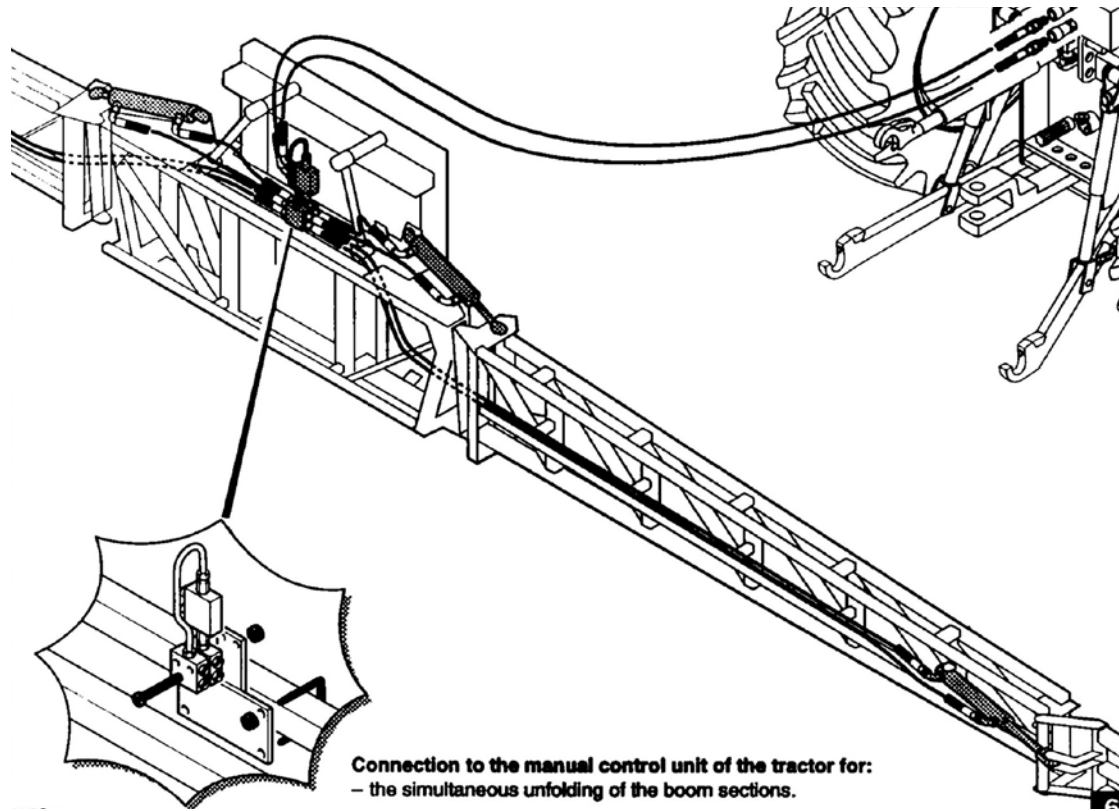

Boom fold hose connection

Connect the boom hydraulic hoses to the tractor, namely:

- a. Boom fold hoses.
- b. Boom parallelogram lift hoses.
- c. If fitted, connect the hoses for the wing lift (optional) - see following pages.
- d. If fitted, connect the hoses for the hydraulic pump drive (optional) - see following pages.

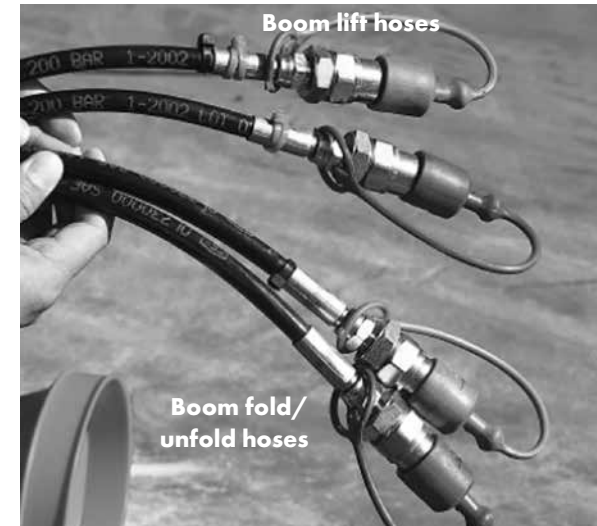

Standard hose connectors for boom lift and fold

### If Quantum Mist Fans Are Fitted

Once the hitch & PTO adjustments are complete, it is important to correctly set up the hydraulic supply for the tractor.

Your dealer will carry out this step to ensure no damage or warranty issues will result from incorrect set up. A small charge may be incurred for this procedure.

A 3/4" return fitting is supplied with your Quantum Mist. This is the DIRECT BACK-TO-TANK fitting required to ensure there is no back-pressure on the oil return from the Quantum Mist sprayer.

On all models, it is important that these steps are done - to make it easy for you to use your sprayer, and to protect the sprayer's hydraulic system:

# SECTION 4

## PRE-OPERATION



Connect hydraulic hoses to the tractor

1. Ask your dealer to fit the 3/4" female return coupler direct back-to-tank.
2. Decide on the best supply remote on your tractor to use for oil supply for the fan system.
3. Plug the 1/2" oil supply line coupling to your selected remote and ensure the hydraulic line does not foul your PTO or any working parts at the rear of the tractor. Allow sufficient slack in the hydraulic line for turning.



3/4" return fitting

4. Hook up the 3/4" return line to the tractor. As with the pressure line, ensure there is sufficient slack & no interference with tractor working parts.

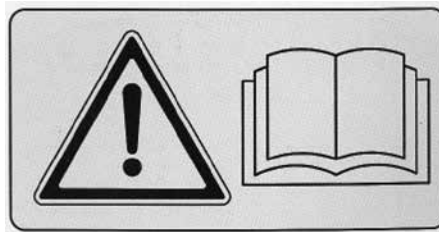

Read Operators' Manuals before operating machine

### PRE-OPERATION CHECKLIST

1. Before attempting to use this machine, Read Operator's Manuals thoroughly.
2. Read and follow instructions on chemical manufacturers labels.
3. Always wear applicable protective clothing.
4. Check that all maintenance procedures have been followed.
5. Check all plumbing and fittings to ensure they are tight, not damaged or leaking.
6. Check PTO shaft or hydraulic pump drive is correctly set up.
7. Grease the PTO shaft if necessary.
8. Check diaphragm pump oil level. (Not applicable if fitted with Hypro centrifugal pump).



Check pump oil level

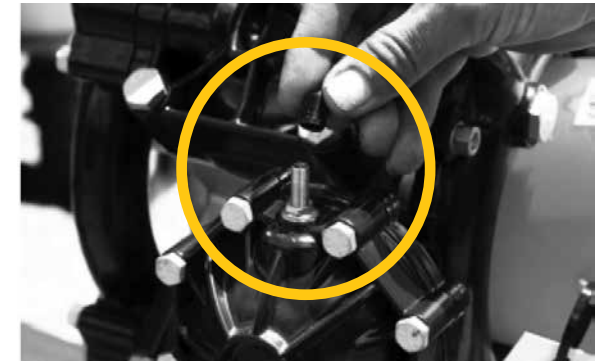

Check pump air chamber pressure

9. Check air pressure in the diaphragm pump air chamber is 70 - 100 kPa (10-15 psi). As a general guideline it should be 10% - 20% of operating pressure. (Not applicable if fitted with Hypro centrifugal pump)

# SECTION 4

## PRE-OPERATION

10. Check that the suction and pressure filters are clean.  
Clean the suction and pressure filters out after initial use, and nozzles if necessary.



Check suction filter is clean



Check the pressure filters are clean.

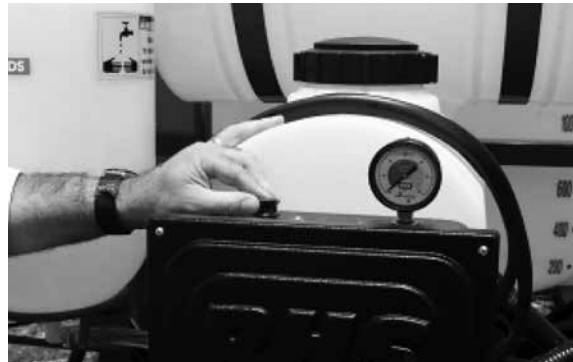

Check foam marker operates correctly

11. Check that the foam marker operates correctly if applicable.
12. Check overall spraying functions using our chosen controller.

### NOTE

**IMPORTANT: Clean the suction filter out after initial use. Whilst all precautions are taken during assembly, it is possible to get filings in the tank and lines.**



# SECTION 5

## SPRAYER OPERATION

### NOTE

This GENERAL manual is a generic overview to a variety of spray operations. It contains information relating to Broadacre and/or Horticulture operations. Some features and options explained in this manual may not be installed on your sprayer.

### EMERGENCY ACTION PLAN

Never operate the sprayer without an action plan in place for when things go wrong ...

**“Take 5”** to evaluate the risks

Actions for most foreseeable machine issues such as breakages start with ...

**“Drop the speed”**

**“Dump the pressure”**

then evaluate further.

|                                      |           |
|--------------------------------------|-----------|
| <b>FILLING THE TANKS</b>             | <b>19</b> |
| <b>FILTER MAINTENANCE</b>            | <b>21</b> |
| <b>CALCULATION FORMULA</b>           | <b>22</b> |
| <b>SPRAYING POINTERS</b>             | <b>23</b> |
| <b>QUANTUM POINTERS</b>              | <b>25</b> |
| <b>TANK &amp; EQUIPMENT CLEANING</b> | <b>26</b> |

# SECTION 5

## SPRAYER OPERATION

### FILLING THE TANKS



Open spray tank lid for top-filling

Your Sprayer has up to four tanks which will all require filling. Each tank can be filled via its top lid. The spray tank and flushing tank can be filled via a top/bottom-filling inlet if this option is fitted.

#### 1. Spray Tank

Use clean, fresh water (preferably rainwater), free of suspended organic matter or clay. Some chemicals are deactivated when they contact these materials.

Always calculate the correct water quantity required, and when filling, allow sufficient water quantity for adding and mixing chemicals. If necessary top up the tank to required quantity after adding chemicals.

#### Main Tank Top-Filling

- Open the spray tank lid and ensure the basket filter is in place.
- Fill the spray tank with the required amount of water.
- Close the spray tank lid.

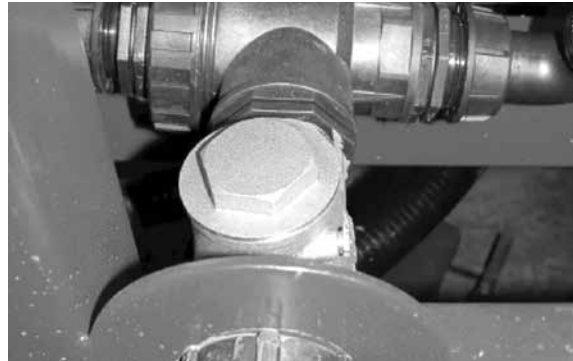

Top/bottom filling inlet

#### Top/Bottom-Fill (Optional) (Main & Flushing Tanks)

The bottom-fill facility requires a pressured water source and is used to fill both the spray tank and flushing tank.

Follow the steps outlined:

- Connect the filling hose to the bottom fill inlet connector.
- Select either the main tank or the flushing tank with the 3-way valve.

- Fill the main or flushing tank with the required amount of water.
- Disconnect filling hose and replace the bottom fill inlet cap.



Open flush tank lid for top-filling

#### 2. Flush Tank - Top Filling

Use clean, fresh water (preferably rainwater) in the flush tank. Always fill the flushing tank before spraying.

To top-fill the flush tank:

- Position the machine and open the flush tank lid.
- Fill the flush tank.
- Close the flush tank lid.

# SECTION 5

## SPRAYER OPERATION



Open flush tank lid for top-filling

### 3. Foam Marker Tanks (Optional)

If your sprayer is fitted with the optional Arag or RHS foam marker, fill with clean fresh water (preferably rainwater).

Use the tank lid for top-filling and adding foam concentrate.

To fill the foam marker tank:

- Unscrew the tank lid.
- Fill the tank with the required amount of water.
- Replace the lid after filling.



Optional RHS 20 l/min foam marker

### 4. Fresh Water Tank (Optional)

A 30 litre fresh water tank. Always fill the optional fresh water tank before spraying.

To fill the fresh water tank:

- Unscrew the tank lid.
- Fill the tank using only rainwater.
- Replace the lid after filling.

## NOTE

**Always add foam concentrate after filling tank with water to minimise foaming when filling.**



Open foam marker lid for filling



Fresh water tank for personal safety

# SECTION 5

## SPRAYER OPERATION

### FILTER MAINTENANCE

Clean filters ensure that no solids enter the spraying system to block or damage pump or nozzles.

All filters should be cleaned regularly or after each spraying period.

#### Suction Filter

The suction filter should be cleaned regularly, or after each spray tank has been emptied.

To clean the suction filter:

1. Completely stop all sprayer functions.
2. Turn the Suction Line valve to "Off" position to shut Off liquid from the spray tank.
3. Remove the outer filter screw and bowl, and then remove the filter and thoroughly clean it before re-assembling the filter.



Remove outer screw and bowl of suction filter

4. Return the Suction Line valve to "Spray" position.



Remove & clean the filter element & components

### NOTE

**Be careful not to damage or deform the mesh or O-ring while cleaning and refitting the filters.**

#### Pressure Filters (if fitted)

The pressure filters should be cleaned regularly, or after each spray tank has been emptied.

### WARNING

**Always wear protective clothing when cleaning filters containing toxic chemicals.**



Reassemble & tighten outer screw of suction filter..

To clean the pressure line filter:

1. Completely stop all sprayer functions.
2. Open the valve at the bottom of the filter to ensure all pressure is removed from the filter.
3. Remove the outer filter bowl, and then remove the filter and thoroughly clean it before re-assembling the filter.

### NOTE

**In some circumstances you may find the nozzle filters are best not used. If your nozzle filters continuously block, check that your main pressure filter is not torn or that the product you are using is not the cause.**

# SECTION 5

## SPRAYER OPERATION

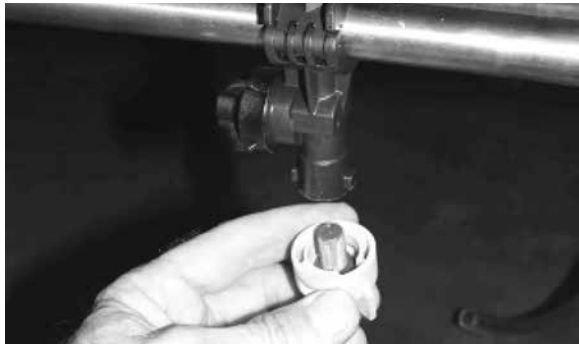

Regularly check and clean nozzle filters

### Nozzle Filters

Nozzle filters should be cleaned regularly to avoid nozzle blockages.

If leaking occurs from the nozzle cap, check caps are correctly fitted with seals &/or the condition of the seals. Replace if necessary.

### Foam Marker Filter

The foam marker filter should be cleaned regularly or after each tank of foam has been emptied.

The foam marker is protected by:

- A 50 mesh filter under the cabinet, &
- A 100 mesh filter located in the line before the liquid orifice.



Remove foam marker filter bowl & 50 mesh screen

## QUANTUM POINTERS, QM-500

### Operating Pointers

While spraying, continually ensure that:

1. Engine and PTO speed are correct.
2. Correct operating pressure is being maintained.
3. Ground speed is correct and constant.
4. Quantum Mist spray heads are operating correctly and aimed toward the target foliage.



Spin mount to move fan closer to canopy, and to allow tilt adjustment

### Position the Spray Heads

The Quantum Mist spray heads can be adjusted individually for width & direction.

Each head should be individually adjusted to maximise coverage and penetration into the target foliage.



Adjust mount for tilt (upwards or downwards) in relation to canopy

### a. Individual Fan Width & Height Adjustment

To individually adjust each Quantum Mist spray head width and height:

1. Loosen the clamp bolts.
2. Adjust the mast or wing uprights and fan head assemblies up or down & in or out.
3. Retighten the clamp bolts after adjustments have been made.
4. Repeat steps 1 - 3 as necessary for each fan head assembly.

# SECTION 5

## SPRAYER OPERATION



Adjust mount for forward/rearward fan adjustment

### b. Directional Adjustment

To adjust individual Quantum Mist fan head direction:

1. Loosen the cradle-to-upright bolts and adjust the head up or down to suit.
2. Retighten the cradle-to-upright bolts.
3. Loosen the cradle-to-motor bolts and adjust the head fore or aft to suit.
4. Retighten the cradle-to-motor bolts.
5. Repeat steps 1 - 4 as necessary for each fan head.

## NOTE

**Refer to the Independent Quantum Mist Report to learn about suitable spray head settings for you canopy.**

### TANK AND EQUIPMENT CLEANING



If a cleaning agent is required (refer to the chemical label), as is often recommended when changing from one chemical group to another or as an end of season clean before storage.

Nufarm's Tank and Equipment Cleaner as pictured above is no longer available. Comparable cleaners are available from most good spray shops.

Below is a guide procedure, but if in doubt, follow the instructions provided with the cleaner.

1. First, completely flush the sprayer with water as outlined in the previous FLUSHING section. Then ...
2. Fill the spray tank with freshwater.
3. Add cleaning agent into the mixer basket (use according to instructions).

4. Open the Tank Selection Valve to the SPRAY tank
5. Open mixing basket valve.
6. Open the agitator valves.
7. Start the Tractor.
8. Make sure the controller / electric controls or auto rate controller is NOT in Spray mode. Ensure TIER 3 is selected to enable both spray rings to be flushed.
9. Start the pump by engaging the Tractor remote (Micro Power Pack version) or PTO. Set to operate at your required rpm, usually between 450 and 540 rpm.
10. Activate the controller SPRAY mode. This will pressurise the system and operate the tank agitators & basket rinse.
11. Adjust to normal operating pressures.
12. Turn ON all spray sections.
  - a. Make sure the area around the fans is clear of bystanders.
  - b. Make sure the fans are downwind of the operator.
  - c. Check that all spray ring taps were activated.
13. After sufficient flushing, turn OFF the spray sections.
14. If you require the cleaning agent to soak or stand for a period, turn the spray booms OFF and completely shut down the sprayer for the desired period.
15. When soaking is completed, start the machine following steps to flush the tank and spray lines.
16. On completion of flushing, shut down all controls and disengage the PTO/ hydraulic drive.
17. Open spray tank drain valve and allow cleaning mixture to drain from the tank.
18. Delay the final flushing of the sprayer (again) with freshwater as outlined in the previous FLUSHING section, until just before the sprayer is next used – that might be in 1 hour or 6 months away if the sprayer is going into storage for the offseason.
19. Wash/hose down the outside of the sprayer completely.

# SECTION 6B

## SPRAYING INFORMATION - BROADACRE

### NOTE

This GENERAL manual is a generic overview to a variety of spray operations. It contains information relating to Broadacre and/or Horticulture operations. Some features and options explained in this manual may not be installed on your sprayer.

|  |           |
|--|-----------|
| <b>CALIBRATION PROCEDURE</b>                 | <b>24</b> |
| <b>AIR-MIX &amp; TURBODROP® NOZZLE CHART</b> | <b>31</b> |
| <b>CALIBRATION WORKSHEET</b>                 | <b>34</b> |

# SECTION 6B

## SPRAYING INFORMATION - BROADACRE

### CALIBRATION PROCEDURE



Proper calibration considers all spraying variables

Applying the correct amount of chemical to a crop is only possible if:

- the sprayer is calibrated correctly
- the sprayer is operated correctly
- the sprayer is maintained correctly

The variables of spray application (distance, time, working width, liquid and chemical volumes) must be measured and controlled accurately to ensure chemicals are applied at the correct rate.

Automatic spray controllers measure and control the variables of speed and flow rate to give constant application.

However proper nozzle selection, checking calibration of nozzles, speed and flow rate as well as correct mixing of chemicals must be done to ensure the accuracy and performance of the sprayer and its controller.

Accurate calibration is essential to ensure uniform application of the recommended dose of chemical to the target.

Proper calibration involves setting up the sprayer (nozzle selection, pressure, speed), calculating chemical and water rates and measuring the performance of the sprayer itself. Only then can you be totally confident in applying chemical correctly.

### Fully Automatic Spray Controllers

Fully automatic spray controllers maintain application rates (set by the operator) when operated in Auto position.

Such controllers monitor speed of travel (speed sensor) and flow rate (flow meter) and automatically adjust flow rate (via a servo valve) to maintain correct application rate irrespective of speed variations within the limits of the nozzles used.

### IMPORTANT:

1. It should be remembered that the spray controller does not eliminate the necessity to measure and check the accuracy of nozzle spray patterns and outputs. These must be checked regularly to ensure correct and uniform application rates because nozzles wear with use.
2. Flow meters used by a controller also need to be checked and calibrated on a regular basis.

On the following page, you will see how to maintain and check an dual line model optional Rapid-check flowmeter.

It is recommended you do this regularly during the spraying season.

See the Controller Operator's Manual for detailed information and calibrating procedures specific to the spray controller.

### Flow Meters

For accurate spray rate application, follow the calibration procedures outlined.

### Calibration Procedure

For accurate spray rate application, follow this calibration procedure:



Rapid Check Flowmeter

### Step 1

#### Ensure Equipment Is In Good Working Order

Tank, pump, boom, filters and nozzles must be clean, free of leakages and functioning properly.

Follow the pre-operation checklist, maintenance and operating instructions in this manual.

Install, calibrate and operate the spray controller according to the spray controller Installation/Operators Manual.

#### Daily Check & Maintenance of Flowmeter

This is to be performed every day after work is finished:

1. Unscrew the assembly that holds the Rapid Check unit in the body.
2. Remove the Rapid Check unit from the body.



# SECTION 6B

## SPRAYING INFORMATION - BROADACRE

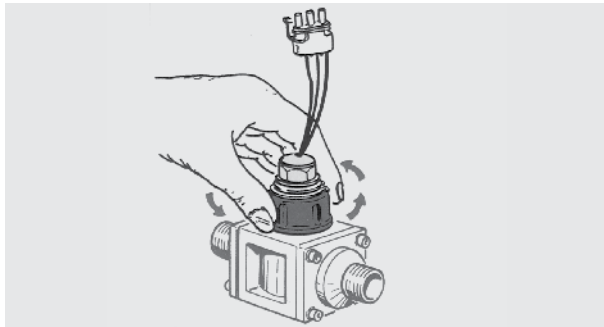

Unscrew the Rapid Check assembly

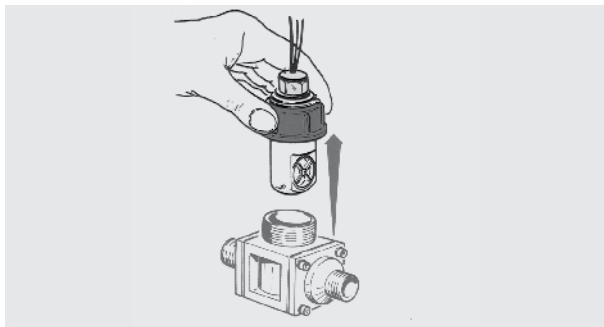

Remove the Rapid Check unit

3. Use clean water to wash any impurities out of the removable turbine unit.

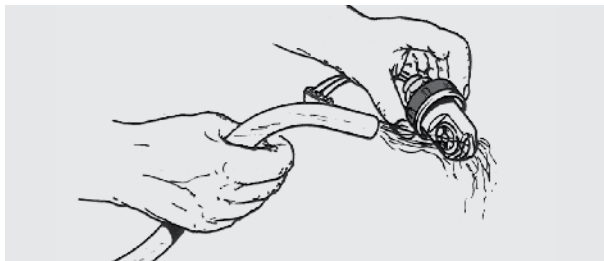

Wash any impurities out of the removable turbine unit

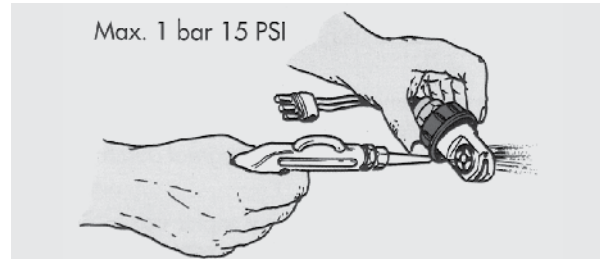

Use compressed air to check that the turbine unit rotates freely

4. Use compressed air to verify that the turbine unit rotates freely (maximum air pressure 1 BAR [15 psi]).

### Every 50 Hours

Carry out the following procedure after every 50 hours of operation:

1. Unscrew the sensor.

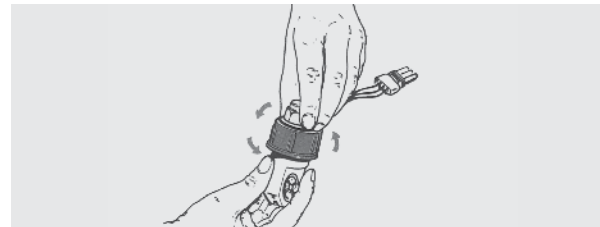

Unscrew the sensor

2. Separate the sensor from the Rapid Check unit.



Separate the sensor from the Rapid Check unit

3. Place the Rapid Check unit in a detergent bath for a few hours.



Place the Rapid Check unit in a detergent bath

4. Remove the Rapid Check unit from detergent bath.

Use compressed air to verify that the turbine unit rotates freely (maximum air pressure 1 BAR [15 psi]).

If necessary, replace the Rapid Check unit with a new one.

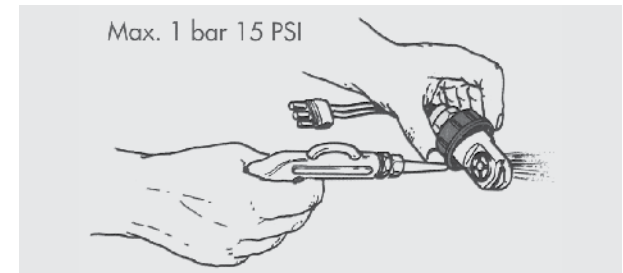

Use compressed air to check that the turbine unit rotates freely

# SECTION 6B

## SPRAYING INFORMATION - BROADACRE

### Step 2

#### Determining the Actual Speed Of Travel

Your sprayer has been factory set with a calibration number. This should be fine tuned prior to commencement of spraying

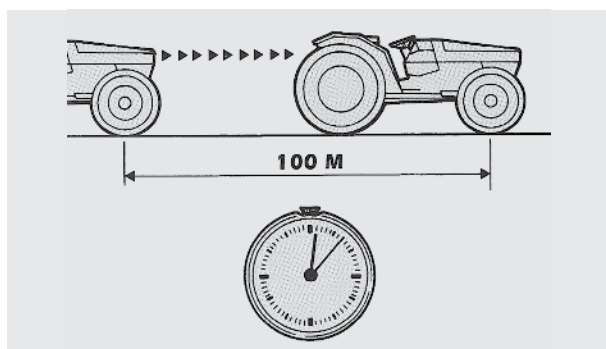

Determine actual speed of travel

and checked by your dealer. This is done by traveling a known distance (usually 100 metres) and comparing the distance measured by the Spray Controller to the known distance. If there is a discrepancy, the Spray Controller Manual explains how to easily adjust the calibration number automatically.

### Step 3

#### Measure Swath Width

The spray controller requires the boom width to be entered in 3/4/5/6 parts.

Measure the nozzle spacing and multiply nozzle spacing by the number of nozzles on each boom section to establish the width of each boom section.

eg.  $0.5\text{m} \times 12 = 6\text{m}$   
 $0.5\text{m} \times 12 = 6\text{m}$   
 $0.5\text{m} \times 12 = 6\text{m}$

## NOTE

Boom sections may vary on some booms.



Agrotop TDam-110-015 Airmix nozzle

### Step 4

#### Select Nozzle Type & Size

Select Nozzle Type & Size according to:

- Chemical recommendations.
- Application rate required.
- Pressure setting.

- Swath width.
- Chosen speed of travel. (Use actual speed of travel, refer to step 2)



AI nozzle - courtesy of Teejet

Two methods of selecting nozzle output are:

- Use the charts on pages 61-63 or the manufacturer's nozzle chart.
- Calculate Required Nozzle Flow Rate.

## NOTE

Boom sections may vary on some booms.

#### a. Use Your Manual's Chart Or Manufacturer's Nozzle Chart

Using the chart on pages 61-63 or the manufacturer's nozzle rate chart, reference:

- Application rate (eg 50 l/ha),
- Speed of travel (eg 12km/hr), &
- Pressure setting (eg 250kPa),  
find the nearest nozzle to suit your requirements.

# SECTION 6B

## SPRAYING INFORMATION - BROADACRE

Also check to see what speed variations are available for applying the same rate. See pages 61-63.

It is usually best to select mid range pressure as this will allow the spray controller to adjust pressure up or down when speed variations occur.

### NOZZLE SELECTION AGROTOP

The chart displays four nozzle models: No. 1 Baller, Weed Stop Only, and two others. Each model includes a diagram, a pressure range, and a spray angle. Key information includes nozzle capacity, spray quality, and nozzle price. The chart also includes a table for nozzle capacity at various speeds.

### b. Calculate Required Nozzle Flow Rate

If you know:

- the application rate required (eg 50 l/ha),
- speed of travel (eg 12km/hr),
- swath width (eg 18m), &
- the number of nozzles on the boom (eg 36).

The following formula can be used to establish required flow rate per nozzle:

$$\text{Nozzle Flow Rate (l/min)} = \frac{\text{Speed (km/hr)} \times \text{Swath Width (m)} \times \text{Application Rate (l/ha)} \div 600 \div \text{Number of nozzles}}$$

eg.  $\frac{[(12 \times 18 \times 50) \div 600] \div 36}{=} 0.5 \text{ l/min for each nozzle}$

An alternative formula is:

$$\text{Nozzle Flow Rate (l/min)} = \frac{\text{Speed (km)} \times \text{Nozzle Spacing (cm)} \times \text{Application Rate (l/ha)} \div 60,000$$

eg.  $\frac{[12 \times 50 \times 50] \div 60,000}{=} 0.5 \text{ l/min}$

Now using the nozzle chart look down the nozzle capacity column (l/min) and select a nozzle to suit the output (eg 0.5 l/min). Refer to pages 61-63 for nozzle charts.

|    |     | L/HA AT VARIOUS SPEEDS (KM/HR) BASED ON A 50CM NOZZLE SPACING |      |      |      |      |       |       |       |       |       |       |       |       |       |       |       |       |       |
|----|-----|---|------|------|------|------|-------|-------|-------|-------|-------|-------|-------|-------|-------|-------|-------|-------|-------|
|    |     | 4   | 8    | 16   | 24   | 32   | 40    | 48    | 56    | 64    | 72    | 80    | 88    | 96    | 104   | 112   | 120   | 128   | 136   |
| 01 | 1.0 | 0.26  | 0.52 | 1.04 | 1.56 | 2.08 | 2.60  | 3.12  | 3.64  | 4.16  | 4.68  | 5.20  | 5.72  | 6.24  | 6.76  | 7.28  | 7.80  | 8.32  | 8.84  |
|    | 2.0 | 0.52  | 1.04 | 2.08 | 3.12 | 4.16 | 5.20  | 6.24  | 7.28  | 8.32  | 9.36  | 10.40 | 11.44 | 12.48 | 13.52 | 14.56 | 15.60 | 16.64 | 17.68 |
| 02 | 1.0 | 0.56  | 1.12 | 2.24 | 3.36 | 4.48 | 5.60  | 6.72  | 7.84  | 8.96  | 10.08 | 11.20 | 12.32 | 13.44 | 14.56 | 15.68 | 16.80 | 17.92 | 19.04 |
|    | 2.0 | 1.12  | 2.24 | 4.48 | 6.72 | 8.96 | 11.20 | 13.44 | 15.68 | 17.92 | 20.16 | 22.40 | 24.64 | 26.88 | 29.12 | 31.36 | 33.60 | 35.84 | 38.08 |

## NOTE

Always use Actual Speed of Travel for speed in the above formula.

### Step 5

#### Fit the Selected Nozzles to the Boom

Fit the selected nozzles to the boom as per the nozzle manufacturers specifications.

## NOTE

Remember when selecting nozzle outputs that higher pressures and wider spray angles usually give finer droplet sizes than lower pressures and narrower spray angles.

### Step 6 (Recommended)

#### Check Nozzle Accuracy & Determine Nozzle Output

Test the actual output of the nozzles using the following procedure:

- Ensure there is adequate water in the tank.  
**IMPORTANT:** Do not use mixed pesticides for testing.
- Start the sprayer and set the spray Controller master switch into MANUAL position and adjust the operating pressure.
- Collect and measure the volume of spray from one nozzle and adjust pressure so that the nozzle gives the specified output (eg 0.5 l/min).

# SECTION 6B

## SPRAYING INFORMATION - BROADACRE



Test the actual output of the nozzles

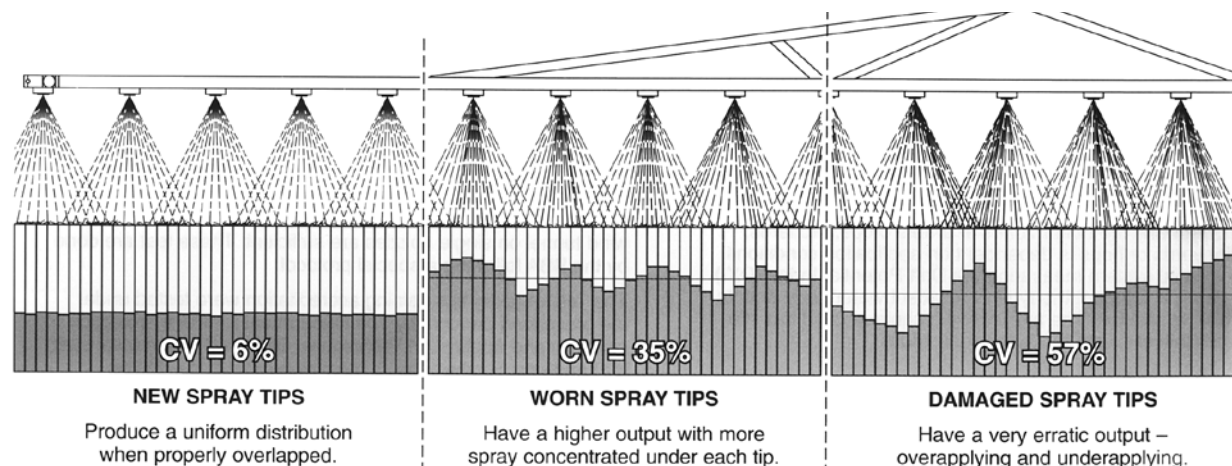

Spray tip wear - courtesy of Teejet



### WARNING

**Do not use mixed pesticides for testing. Use only clean water. Use of pesticides when testing is hazardous to your health.**

#### IMPORTANT:

Do not use a worn nozzle to set the pressure setting and nozzle rates.



### CAUTION

**Do not use a worn nozzles to set the pressure setting and nozzle rates, otherwise inaccurate calibration will occur.**

If the boom is not fitted with new nozzles, fit one new nozzle and use it to set the flow rate and pressure setting.

This sets the standard flow rate, pressure setting and spray pattern with which to test the performance of other nozzles.

d. When the pressure is set to give a specified nozzle output (using a new

nozzle), collect and measure the volume of spray from each nozzle for one minute in a collection jar or calibrating jug.

Specially designed nozzle testing equipment such as nozzle calibrating jugs can be used to simplify nozzle calibration.

e. Visually check nozzle spray patterns and spray angle for accuracy and, if necessary, replace any faulty nozzles.

f. Discard and replace any nozzle that deviates more than 10% from the specified output (eg with a 0.5 l/min specification- discard any nozzles 0.45 l/min and under or 0.55 l/min and over).

g. Check replacement nozzles by collecting and measuring output from each replacement.

h. Record the output of each nozzle on the boom. Add the outputs together and divide by the number of nozzles to get the required output of each nozzles in one minute.

eg.  $\frac{\text{Total spray output } 18 \text{ l/min}}{36 \text{ nozzles}} = 0.5 \text{ l/min per nozzle}$

#### Step 7

##### Calculate Application Rate

When operating the spray controller, the controller automatically calculates and shows the rate of application.

# SECTION 6B

## SPRAYING INFORMATION - BROADACRE

$$\frac{\text{Application Rate (l/ha)}}{\text{Spray Output (l/min)} \times 600 \div \text{Speed (km/hr)} \times \text{Swath Width (m)}}$$

eg. 
$$\frac{[18 \times 600] \div [12 \times 18]}{= 50 \text{ l/ha}}$$

### Step 8

#### If tested application is not satisfactory:

- a. In Auto mode - if application rate is not being achieved:
  - i. Operating pressure will climb if nozzles are too small or blocked or speed is too slow.  
Likewise, if your pressure filter is blocked (even partially), you may experience excessive pressure at the pump.  
Make adjustments accordingly.
  - ii. Operating pressure will fall if nozzles are too large or speed is too slow. Make adjustments accordingly.
- b. In Manual mode - the Controller application rate can be altered by:
  - i. Adjusting pressure up or down to increase or decrease rate of application (use +/- keys).
  - ii. Adjusting spraying speed up or down to decrease or increase rate of application.
  - iii. Changing to a different nozzle capacity.

### Step 9

#### Add The Correct Amount Of Chemical To The Tank

- a. For land area rates (litres or kg per hectare), use the following formula:

$$\frac{\text{Chemical Required (litres)}}{\text{Tank Volume (litres)} \times \text{Recommended Chemical Rate (l/ha)} \div \text{Spray Application Rate (l/ha)}}$$

eg. 
$$\frac{[2000 \times 2.0] \div 50}{= 80 \text{ litres}}$$

- b. If chemical recommendation is given in water volume rates use the following formula:

$$\frac{\text{Chemical Required (litres)}}{\text{Tank Volume (litres)} \times \text{Recommended Chemical Rate (l/100 litres)} \div 100}$$

eg. 
$$\frac{[2000 \times 4] \div 100}{= 80 \text{ litres}}$$

- c. For land area covered, use the formula:

$$\frac{\text{Area Covered (ha)}}{\text{Tank Volume (litres)} \div \text{Spray Application Rate (l/ha)}}$$

eg. 
$$\frac{2000 \div 50}{= 40 \text{ hectares}}$$

- d. For tank volume required, use the formula:

$$\frac{\text{Tank Volume Required (litres)}}{\text{Area (ha)} \times \text{Spray Application Rate (l/ha)}}$$

eg. 
$$\frac{20 \times 50}{= 1000 \text{ litres}}$$

## NOTE

**Full instructions of controller operation are contained in your separate Controller Manual.**

## NOTE

**All nozzles have a pressure and flow rate range to achieve the best results. Ensure you have selected the nozzle which best suits your application to avoid any problems.**

### Step 10

#### Adjust Boom Height

Boom height should be adjusted to suit the type of nozzle used, terrain and crop or soil being sprayed. Minimum boom height recommendations depend on the nozzle spray angle and nozzle spacing. Refer to Nozzle chart recommendations.

# SECTION 6B

## SPRAYING INFORMATION - BROADACRE

### Optimum Spray Height

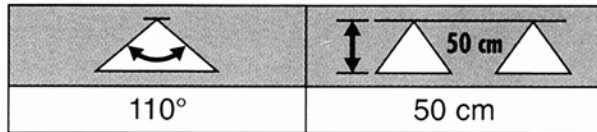

#### Step 11

##### Record All Data For Future Reference

Record all your calibration data on the work sheets given at the end of this section.

Photocopy the work sheets to obtain the number of work sheets required.

# SECTION 6B

## SPRAYING INFORMATION - BROADACRE

### AIR-MIX & TURBODROP® NOZZLE CHART

| Litres/ha @ 500mm nozzle spacing          |     |       |       |       |       |       |        |        |        |        |        |        |        |
|---|-----|-------|-------|-------|-------|-------|--------|--------|--------|--------|--------|--------|--------|
| Nozzle                                    | Bar | l/min | 5km/h | 6km/h | 7km/h | 8km/h | 10km/h | 12km/h | 16km/h | 20km/h | 25km/h | 30km/h | 35km/h |
| <b>TDAM015</b><br><b>TD015</b><br>(Green) | 1   | 0,346 | 83    | 69    | 59    | 52    | 42     | 35     | 26     | 21     |        |        |        |
|   | 2   | 0,490 | 118   | 98    | 84    | 74    | 59     | 49     | 36     | 29     |        |        |        |
|   | 3   | 0,600 | 144   | 120   | 103   | 90    | 72     | 60     | 45     | 36     |        |        |        |
|   | 4   | 0,693 | 166   | 139   | 119   | 104   | 83     | 69     | 52     | 42     |        |        |        |
|   | 5   | 0,775 | 186   | 155   | 133   | 116   | 93     | 77     | 58     | 47     |        |        |        |
|   | 6   | 0,849 | 204   | 170   | 146   | 127   | 102    | 85     | 64     | 51     |        |        |        |
|   | 7   | 0,917 | 220   | 183   | 157   | 138   | 110    | 92     | 69     | 55     |        |        |        |
|   | 8   | 0,980 | 235   | 196   | 168   | 147   | 118    | 98     | 74     | 59     |        |        |        |
|   | 9   | 1,039 | 249   | 208   | 178   | 156   | 125    | 104    | 78     | 63     |        |        |        |
|   | 10  | 1,095 | 263   | 219   | 188   | 164   | 132    | 109    | 82     | 66     |        |        |        |
| <b>TDAM02</b><br><b>TD02</b><br>(Yellow)  | 1   | 0,462 | 111   | 92    | 79    | 69    | 55     | 46     | 35     | 28     |        |        |        |
|   | 2   | 0,653 | 157   | 131   | 112   | 98    | 78     | 65     | 49     | 39     |        |        |        |
|   | 3   | 0,800 | 192   | 160   | 137   | 120   | 96     | 80     | 60     | 48     |        |        |        |
|   | 4   | 0,924 | 222   | 185   | 159   | 139   | 111    | 92     | 69     | 56     |        |        |        |
|   | 5   | 1,033 | 248   | 207   | 177   | 155   | 124    | 103    | 77     | 62     |        |        |        |
|   | 6   | 1,131 | 271   | 226   | 94    | 170   | 136    | 113    | 85     | 68     |        |        |        |
|   | 7   | 1,222 | 293   | 244   | 209   | 183   | 147    | 122    | 92     | 73     |        |        |        |
|   | 8   | 1,306 | 313   | 261   | 224   | 196   | 157    | 131    | 98     | 78     |        |        |        |
|   | 9   | 1,386 | 332   | 277   | 237   | 208   | 166    | 139    | 104    | 83     |        |        |        |
|   | 10  | 1,460 | 350   | 292   | 250   | 219   | 175    | 146    | 110    | 88     |        |        |        |
| <b>TDAM025</b><br><b>TD025</b><br>(Lilac) | 1   | 0,577 | 138   | 115   | 99    | 87    | 69     | 58     | 43     | 35     |        |        |        |
|   | 2   | 0,816 | 196   | 163   | 140   | 122   | 98     | 82     | 61     | 49     |        |        |        |
|   | 3   | 1,000 | 240   | 200   | 171   | 150   | 120    | 100    | 75     | 60     |        |        |        |
|   | 4   | 1,154 | 278   | 231   | 199   | 174   | 139    | 115    | 86     | 70     |        |        |        |
|   | 5   | 1,291 | 310   | 259   | 221   | 194   | 155    | 129    | 96     | 78     |        |        |        |
|   | 6   | 1,414 | 339   | 283   | 243   | 213   | 170    | 141    | 106    | 85     |        |        |        |
|   | 7   | 1,528 | 366   | 305   | 261   | 229   | 184    | 153    | 115    | 92     |        |        |        |
|   | 8   | 1,632 | 391   | 326   | 280   | 245   | 196    | 163    | 122    | 98     |        |        |        |
|   | 9   | 1,732 | 415   | 346   | 296   | 260   | 208    | 174    | 130    | 104    |        |        |        |
|   | 10  | 1,826 | 438   | 365   | 313   | 274   | 219    | 183    | 138    | 110    |        |        |        |
| <b>TDAM03</b><br><b>TD03</b><br>(Blue)    | 1   | 0,693 | 166   | 139   | 119   | 104   | 83     | 69     | 52     | 42     |        |        |        |
|   | 2   | 0,980 | 234   | 196   | 168   | 147   | 118    | 98     | 74     | 59     |        |        |        |
|   | 3   | 1,200 | 288   | 240   | 206   | 180   | 144    | 120    | 90     | 72     |        |        |        |
|   | 4   | 1,385 | 333   | 278   | 238   | 208   | 166    | 138    | 104    | 84     |        |        |        |
|   | 5   | 1,549 | 372   | 310   | 266   | 232   | 186    | 154    | 116    | 94     |        |        |        |
|   | 6   | 1,697 | 408   | 340   | 292   | 254   | 204    | 170    | 128    | 102    |        |        |        |
|   | 7   | 1,833 | 440   | 366   | 314   | 276   | 220    | 184    | 138    | 110    |        |        |        |
|   | 8   | 1,960 | 460   | 392   | 336   | 294   | 236    | 196    | 148    | 118    |        |        |        |
|   | 9   | 2,078 | 498   | 416   | 356   | 312   | 250    | 208    | 156    | 126    |        |        |        |
|   | 10  | 2,191 | 526   | 438   | 376   | 328   | 264    | 218    | 164    | 132    |        |        |        |

# SECTION 6B

## SPRAYING INFORMATION - BROADACRE

### AIR-MIX & TURBODROP® NOZZLE CHART

|             |              | Application Rate (l/ha with km/h @ 50cm nozzle spacing) |      |      |      |      |      |      |      |      |      |      |      |      |      |      |      |
|-------------|--------------|---|------|------|------|------|------|------|------|------|------|------|------|------|------|------|------|
| Nozzle Type | Pressure Bar | Flow Rate l/min   | 4    | 6    | 8    | 10   | 12   | 14   | 16   | 18   | 20   | 22   | 24   | 26   | 28   | 30   | 35   |
| 110-015     | 1            | 0.231   | 46.2 | 46.2 | 34.7 | 27.7 | 23.1 | 19.8 | 17.3 | 15.4 | 13.9 | 12.6 | 11.6 | 10.7 | 9.9  | 9.24 | 7.92 |
|             | 1.5          | 0.283   | 84.9 | 56.6 | 42.5 | 34   | 28.3 | 24.3 | 21.2 | 18.9 | 17   | 15.4 | 14.2 | 13.1 | 12.1 | 11.3 | 9.7  |
|             | 2            | 0.327   | 98.1 | 65.4 | 49.1 | 39.2 | 32.7 | 28   | 24.5 | 21.8 | 19.6 | 17.8 | 16.4 | 15.1 | 14   | 13.1 | 11.2 |
|             | 3            | 0.4   | 120  | 80   | 60   | 48   | 40   | 34.3 | 30   | 26.7 | 24   | 21.8 | 20   | 18.5 | 17.1 | 16   | 13.7 |
|             | 4            | 0.462   | 139  | 92.4 | 69.3 | 55.4 | 46.2 | 39.6 | 34.7 | 30.8 | 27.7 | 25.2 | 23.1 | 21.3 | 19.8 | 18.5 | 15.8 |
|             | 5            | 0.517   | 155  | 103  | 77.6 | 62   | 51.7 | 44.3 | 38.8 | 34.5 | 31   | 28.2 | 25.9 | 23.9 | 22.2 | 20.7 | 17.7 |
|             | 6            | 0.566   | 170  | 113  | 84.9 | 67.9 | 56.6 | 48.5 | 42.5 | 37.7 | 34   | 30.9 | 28.3 | 26.1 | 24.3 | 22.6 | 19.4 |
| 110-015     | 1            | 0.346   | 69.2 | 69.2 | 51.9 | 41.5 | 34.6 | 29.7 | 26   | 23.1 | 20.8 | 18.9 | 17.3 | 16   | 14.8 | 13.8 | 11.9 |
|             | 1.5          | 0.424   | 127  | 84.8 | 63.6 | 50.9 | 42.4 | 36.3 | 31.8 | 28.3 | 25.4 | 23.1 | 21.2 | 19.6 | 18.2 | 17   | 14.5 |
|             | 2            | 0.49  | 147  | 98   | 73.5 | 58.8 | 49   | 42   | 36.8 | 32.7 | 29.4 | 26.7 | 24.5 | 22.6 | 21   | 19.6 | 16.8 |
|             | 3            | 0.6   | 180  | 120  | 90   | 72   | 60   | 51.4 | 45   | 40   | 36   | 32.7 | 30   | 27.7 | 25.7 | 24   | 20.6 |
|             | 4            | 0.693   | 208  | 139  | 104  | 83.2 | 69.3 | 59.4 | 52   | 46.2 | 41.6 | 37.8 | 34.7 | 32   | 29.7 | 27.7 | 23.8 |
|             | 5            | 0.775   | 233  | 155  | 116  | 93   | 77.5 | 66.4 | 58.1 | 51.7 | 46.5 | 42.3 | 38.8 | 35.8 | 33.2 | 31   | 26.6 |
|             | 6            | 0.849   | 255  | 170  | 127  | 102  | 84.9 | 72.8 | 63.7 | 56.6 | 50.9 | 46.3 | 42.5 | 39.2 | 36.4 | 34   | 29.1 |
| 110-02      | 1            | 0.462   | 92.4 | 92.4 | 69.3 | 55.4 | 46.2 | 39.6 | 34.7 | 30.8 | 27.7 | 25.2 | 23.1 | 21.3 | 19.8 | 18.5 | 15.8 |
|             | 1.5          | 0.566   | 170  | 113  | 84.9 | 67.9 | 56.6 | 48.5 | 42.5 | 37.7 | 34   | 30.9 | 28.3 | 26.1 | 24.3 | 22.6 | 19.4 |
|             | 2            | 0.653   | 196  | 131  | 98   | 78.4 | 65.3 | 56   | 49   | 43.5 | 39.2 | 35.6 | 32.7 | 30.1 | 28   | 26.1 | 22.4 |
|             | 3            | 0.8   | 240  | 160  | 120  | 96   | 80   | 68.6 | 60   | 53.3 | 48   | 43.6 | 40   | 36.9 | 34.3 | 32   | 27.4 |
|             | 4            | 0.924   | 277  | 185  | 139  | 111  | 92.4 | 79.2 | 69.3 | 61.6 | 55.4 | 50.4 | 46.2 | 42.6 | 39.6 | 37   | 31.7 |
|             | 5            | 1.033   | 310  | 207  | 155  | 124  | 103  | 88.5 | 77.5 | 68.9 | 62   | 56.3 | 51.7 | 47.7 | 44.3 | 41.3 | 35.4 |
|             | 6            | 1.131   | 339  | 226  | 170  | 136  | 113  | 96.9 | 84.8 | 75.4 | 67.9 | 61.7 | 56.6 | 52.2 | 48.5 | 45.2 | 38.8 |
| 110-025     | 1            | 0.577   | 115  | 115  | 86.6 | 69.2 | 57.7 | 49.5 | 43.3 | 38.5 | 34.6 | 31.5 | 28.9 | 26.6 | 24.7 | 23.1 | 19.8 |
|             | 1.5          | 0.707   | 212  | 141  | 106  | 84.8 | 70.7 | 60.6 | 53   | 47.1 | 42.4 | 38.6 | 35.4 | 32.6 | 30.3 | 28.3 | 24.2 |
|             | 2            | 0.816   | 245  | 163  | 122  | 97.9 | 81.6 | 69.9 | 61.2 | 54.4 | 49   | 44.5 | 40.8 | 37.7 | 35   | 32.6 | 28   |
|             | 3            | 1   | 300  | 200  | 150  | 120  | 100  | 85.7 | 75   | 66.7 | 60   | 54.5 | 50   | 46.2 | 42.9 | 40   | 34.3 |
|             | 4            | 1.154   | 346  | 231  | 173  | 138  | 115  | 98.9 | 86.6 | 76.9 | 69.2 | 62.9 | 57.7 | 53.3 | 49.5 | 46.2 | 39.6 |
|             | 5            | 1.291   | 387  | 258  | 194  | 155  | 129  | 111  | 96.8 | 86.1 | 77.5 | 70.4 | 64.6 | 59.6 | 55.3 | 51.6 | 44.3 |
|             | 6            | 1.414   | 424  | 283  | 212  | 170  | 141  | 121  | 106  | 94.3 | 84.8 | 77.1 | 70.7 | 65.3 | 60.6 | 56.6 | 48.5 |



# SECTION 6B

## SPRAYING INFORMATION - BROADACRE

### AIR-MIX & TURBODROP® NOZZLE CHART

| Application Rate (l/ha with km/h @ 50cm nozzle spacing) |              |                 |      |     |     |      |      |      |      |      |      |      |      |      |      |      |      |
|---|--------------|-----------------|------|-----|-----|------|------|------|------|------|------|------|------|------|------|------|------|
| Nozzle Type   | Pressure Bar | Flow Rate l/min | 4    | 6   | 8   | 10   | 12   | 14   | 16   | 18   | 20   | 22   | 24   | 26   | 28   | 30   | 35   |
| 110-03  | 1            | 0.693           | 139  | 139 | 104 | 83.2 | 69.3 | 59.4 | 52   | 46.2 | 41.6 | 37.8 | 34.7 | 32   | 29.7 | 27.7 | 23.8 |
|   | 1.5          | 0.849           | 255  | 170 | 127 | 102  | 84.9 | 72.8 | 63.7 | 56.6 | 50.9 | 46.3 | 42.5 | 39.2 | 36.4 | 34   | 29.1 |
|   | 2            | 0.98            | 294  | 196 | 147 | 118  | 98   | 84   | 73.5 | 65.3 | 58.8 | 53.5 | 49   | 45.2 | 42   | 39.2 | 33.6 |
|   | 3            | 1.2             | 360  | 240 | 180 | 144  | 120  | 103  | 90   | 80   | 72   | 65.5 | 60   | 55.4 | 51.4 | 48   | 41.1 |
|   | 4            | 1.386           | 416  | 277 | 208 | 166  | 139  | 119  | 104  | 92.4 | 83.2 | 75.6 | 69.3 | 64   | 59.4 | 55.4 | 47.5 |
|   | 5            | 1.549           | 465  | 310 | 232 | 186  | 155  | 133  | 116  | 103  | 92.9 | 84.5 | 77.5 | 71.5 | 66.4 | 62   | 53.1 |
|   | 6            | 1.697           | 509  | 339 | 255 | 204  | 170  | 145  | 127  | 113  | 102  | 92.6 | 84.9 | 78.3 | 72.7 | 67.9 | 58.2 |
| 110-04  | 1            | 0.924           | 185  | 185 | 139 | 111  | 92.4 | 79.2 | 69.3 | 61.6 | 55.4 | 50.4 | 46.2 | 42.6 | 39.6 | 37   | 31.7 |
|   | 1.5          | 1.113           | 334  | 223 | 167 | 134  | 111  | 95.4 | 83.5 | 74.2 | 66.8 | 60.7 | 55.7 | 51.4 | 47.7 | 44.5 | 38.2 |
|   | 2            | 1.306           | 392  | 261 | 196 | 157  | 131  | 112  | 98   | 87.1 | 78.4 | 71.2 | 65.3 | 60.3 | 56   | 52.2 | 44.8 |
|   | 3            | 1.6             | 480  | 320 | 240 | 192  | 160  | 137  | 120  | 107  | 96   | 87.3 | 80   | 73.8 | 68.6 | 64   | 54.9 |
|   | 4            | 1.848           | 554  | 370 | 277 | 222  | 185  | 158  | 139  | 123  | 111  | 101  | 92.4 | 85.3 | 79.2 | 73.9 | 63.4 |
|   | 5            | 2.066           | 620  | 413 | 310 | 248  | 207  | 177  | 155  | 138  | 124  | 113  | 103  | 95.4 | 88.5 | 82.6 | 70.8 |
|   | 6            | 2.263           | 679  | 453 | 339 | 272  | 226  | 194  | 170  | 151  | 136  | 123  | 113  | 104  | 97   | 90.5 | 77.6 |
| 110-05  | 1            | 1.155           | 231  | 231 | 173 | 139  | 116  | 99   | 86.6 | 77   | 69.3 | 63   | 57.8 | 53.3 | 49.5 | 46.2 | 39.6 |
|   | 1.5          | 1.414           | 424  | 283 | 212 | 170  | 141  | 121  | 106  | 94.3 | 84.8 | 77.1 | 70.7 | 65.3 | 60.6 | 56.6 | 48.5 |
|   | 2            | 1.633           | 490  | 327 | 245 | 196  | 163  | 140  | 122  | 109  | 98   | 89.1 | 81.7 | 75.4 | 70   | 65.3 | 56   |
|   | 3            | 2               | 600  | 400 | 300 | 240  | 200  | 171  | 150  | 133  | 120  | 109  | 100  | 92.3 | 85.7 | 80   | 68.6 |
|   | 4            | 2.309           | 693  | 462 | 346 | 277  | 231  | 198  | 173  | 154  | 139  | 126  | 115  | 107  | 99   | 92.4 | 79.2 |
|   | 5            | 2.582           | 775  | 516 | 387 | 310  | 258  | 221  | 194  | 172  | 155  | 141  | 129  | 119  | 111  | 103  | 88.5 |
|   | 6            | 2.828           | 848  | 566 | 424 | 339  | 283  | 242  | 212  | 189  | 170  | 154  | 141  | 131  | 121  | 113  | 97   |
| 110-06  | 1            | 1.386           | 277  | 277 | 208 | 166  | 139  | 119  | 104  | 92.4 | 83.2 | 75.6 | 69.3 | 64   | 59.4 | 55.4 | 47.5 |
|   | 1.5          | 1.697           | 509  | 339 | 255 | 204  | 170  | 145  | 127  | 113  | 102  | 92.6 | 84.9 | 78.3 | 72.7 | 67.9 | 58.2 |
|   | 2            | 1.96            | 588  | 392 | 294 | 235  | 196  | 168  | 147  | 131  | 118  | 107  | 98   | 90.5 | 84   | 78.4 | 67.2 |
|   | 3            | 2.4             | 720  | 480 | 360 | 288  | 240  | 206  | 180  | 160  | 144  | 131  | 120  | 111  | 103  | 96   | 82.3 |
|   | 4            | 2.771           | 831  | 554 | 416 | 333  | 277  | 238  | 208  | 185  | 166  | 151  | 139  | 128  | 119  | 111  | 95   |
|   | 5            | 3.098           | 929  | 620 | 465 | 372  | 310  | 266  | 232  | 207  | 186  | 169  | 155  | 143  | 133  | 124  | 106  |
|   | 6            | 3.394           | 1018 | 679 | 509 | 407  | 339  | 291  | 255  | 226  | 204  | 185  | 170  | 157  | 145  | 136  | 116  |

# SECTION 6B

## SPRAYING INFORMATION - BROADACRE

### CALIBRATION WORK SHEET

#### Step 1

Check the Sprayer is in Good Working Order

#### Step 2

##### Determine Actual Speed of Travel

Follow Instructions on page 6.4 (Speed Calibration).

|               |  |
|---------------|--|
| Tractor model |  |
| Gear          |  |
| Range         |  |
| Dual power    |  |
| Engine RPM    |  |
| Speed in Km/h |  |

#### Step 3

##### Measure Boom Widths

|                 |  |
|-----------------|--|
| Boom section 1: |  |
| Boom section 2: |  |
| Boom section 3: |  |
| Boom section 4: |  |
| Boom section 5: |  |
| Boom section 6: |  |
| Boom section 7: |  |

#### Step 4

##### Select Nozzle Type & Size

|                                     |  |
|-------------------------------------|--|
| Chemical:                           |  |
| Type of Nozzle:                     |  |
| Pressure Setting:                   |  |
| Travel speed (km/hr):               |  |
| Total number of nozzles to be used: |  |

$$\text{Nozzle Flow Rate (l/min)} = \frac{\text{Speed (km/hr)} \times \text{Swath Width (m)} \times \text{Application Rate (l/ha)}}{600 \div \text{Number of nozzles}}$$

$$\begin{matrix} \boxed{\phantom{00}} & \times & \boxed{\phantom{00}} & \times & \boxed{\phantom{00}} & \div & 600 & \div & \boxed{\phantom{00}} \\ = & & \boxed{\phantom{00}} & & \boxed{\phantom{00}} & & \text{l/min for each nozzle} \end{matrix}$$

#### Step 5

##### Fit Selected Nozzles to Boom

|                |  |
|----------------|--|
| Nozzle Type:   |  |
| Nozzle Size:   |  |
| Nozzle Colour: |  |

#### Step 6

##### Check Nozzle Accuracy & Determine Nozzle Output

Thoroughly check nozzles & test the actual output of each nozzle.

|                            |  |
|----------------------------|--|
| Pressure Setting:          |  |
| Individual Nozzle Outputs: |  |
|                            |  |
|                            |  |
| Sum of Nozzle Outputs:     |  |

#### Step 7

##### Calculate Application Rate

The spray Controller automatically calculates and shows the rate of application.

$$\text{Application Rate (l/ha)} = \frac{\text{Spray Output (l/min)} \times 600}{\text{Speed (km/hr)} \times \text{Swath Width (m)}}$$

$$\begin{matrix} [ \boxed{\phantom{00}} \times 600 ] \div [ \boxed{\phantom{00}} \times \boxed{\phantom{00}} ] \\ = \boxed{\phantom{00}} \end{matrix}$$

#### Step 8

If Tested Application is Not Satisfactory - Make Changes & Repeat Procedure

|  |  |
|--|--|
|  |  |
|  |  |

#### Step 9

##### Add Correct Amount of Chemical

|                 |  |
|-----------------|--|
| Chemical:       |  |
| Water Quantity: |  |
| Chemical Added: |  |

#### Step 10

##### Boom Height

#### Step 11

##### Record Data

|                        |  |
|------------------------|--|
| Date                   |  |
| Farm location          |  |
| Crop to be sprayed     |  |
| Spray Volume litres/ha |  |
| Nozzle type            |  |
| Nozzle size & colour   |  |
| No. of nozzles used    |  |
| Nozzle pressure        |  |
| Tested Output in l/min |  |
| Actual Litres/Hectare  |  |

# SECTION 6H

## SPRAYING INFORMATION - HORTICULTURE

### NOTE

This GENERAL manual is a generic overview to a variety of spray operations. It contains information relating to Broadacre and/or Horticulture operations. Some features and options explained in this manual may not be installed on your sprayer.

|   |           |
|---|-----------|
| <b>SPRAYWISE</b>  | <b>36</b> |
| <b>CALIBRATION WORKSHEET</b>                                    | <b>36</b> |
| <b>FLOWMETER CALIBRATION</b>                                    | <b>37</b> |
| <b>STEP 1 - ENSURE EQUIPMENT IS IN GOOD WORKING ORDER</b>       | <b>37</b> |
| <b>STEP 2 - DETERMINING THE ACTUAL SPEED OF TRAVEL</b>          | <b>39</b> |
| <b>STEP 3 - DETERMINE SPRAYING VOLUME REQUIRED</b>              | <b>39</b> |
| <b>STEP 4 - DETERMINE SPRAYER CONFIGURATION</b>                 | <b>39</b> |
| <b>STEP 5 - DETERMINE THE IDEAL SPRAY PRESSURE</b>              | <b>40</b> |
| <b>STEP 6 - DETERMINE &amp; SELECT CORRECT NOZZLES</b>          | <b>40</b> |
| <b>STEP 7 - FIT &amp; TEST SELECTED NOZZLES</b>                 | <b>41</b> |
| <b>STEP 8 - CALCULATE THE ACTUAL APPLICATION RATE</b>           | <b>41</b> |
| <b>STEP 9 - IF THE TESTED RATE IS UNSATISFACTORY</b>            | <b>42</b> |
| <b>STEP 10 - COVERAGE ASSESSMENT</b>                            | <b>43</b> |
| <b>STEP 11 - ADD THE CORRECT AMOUNT OF CHEMICAL TO THE TANK</b> | <b>43</b> |
| <b>STEP 12 - RECORD ALL DATA FOR FUTURE REFERENCE</b>           | <b>44</b> |
| <b>CALIBRATION WORK SHEET</b>                                   | <b>45</b> |

# SECTION 6H

## SPRAYING INFORMATION - HORTICULTURE

Spraying should be done in conjunction with an agronomist / spray manager / someone skilled in the art of spraying. The best setup might vary significantly from crop to crop, season to season etc.

### SPRAYWISE

It's highly recommended that all operators of this sprayer and spray program managers should be fully conversant with the information supplied in the **Nufarm SprayWise Horticultural Application Handbook** (refer photo) before undertaking spray operations.

The book includes chapters discussing re;

- Droplet Size
- Nozzle Types
- Dilute Spraying
- Concentrate Spraying
- Coverage & Assessment
- Selecting Nozzles
- Drift
- Weather
- Adjuvants
- Formulations & Mixing Order
- Cleaning
- Calibration
- Record Keeping
- And more

This book is supplied with every QM-420 Sprayer, and is available from Croplands dealers, under the part number: SPRAYWISEHK.



### CALIBRATION

Applying the correct amount of chemical to a crop is only possible if **the sprayer is calibrated, operated and maintained correctly.**

The variables of spray application (distance, time, working width, liquid, and chemical volumes) must be measured and controlled accurately to ensure chemicals are applied at the correct rate.

Proper calibration involves setting up the sprayer (nozzle selection, pressure, speed), calculating chemical and water rates, and measuring the performance of the sprayer itself. Only then can you be totally confident in applying chemicals correctly.

### Fully Automatic Spray Controller (HV4000/ Bravo 180)

Automatic spray controllers maintain the application rate (as set by the operator) when operated in the Auto position.

The controller monitors speed of travel (speed sensor) and flow rate (flow meter) and automatically adjusts flow rate (via a pressure regulating or servo valve) to maintain the correct application rate irrespective of speed variations within the limits of the nozzles used.

### IMPORTANT:

- It should be remembered that the spray controller does not eliminate the necessity to measure and check the accuracy of nozzle spray patterns and outputs. These must be checked regularly to ensure correct and uniform application rates because nozzles wear with use.

# SECTION 6H

## SPRAYING INFORMATION - HORTICULTURE

- Flow meters used by the Quantum Mist QM-420 Sprayer need to be checked and calibrated on a regular basis.

The following page demonstrates how to maintain and check your Rapid-check flowmeter. It is recommended this is done regularly during the spraying season.



### FLOWMETER CALIBRATION

If optioned with auto rate controller, as a part of the initial factory testing / calibration, a value (pulses per litre) will have been recorded and written on the body of the flow meter see example on page 30.

To check / improve the resolution of the flow meter calibration use the below method after having sprayed out a reasonable volume of liquid (the more sprayed the better the resolution);

- The current flow meter calibration number in the controller = X
- Take the total volume the controller says was sprayed and divided by the actual volume sprayed = Your new flow meter calibration.

- Then manually enter this number into the controller settings.

For example;

Current flow cal number (X) = 250. Controller says we have sprayed 4400L after having put 4000L in the tank.

$$250 \times 4400 = 1100000$$

$$1100000 / 4000 = 275 \text{ (new flow cal number)}$$

### STEP 1 - ENSURE EQUIPMENT IS IN GOOD WORKING ORDER

Tank, pump, boom, filters and nozzles must be clean, free of leakages and functioning properly.

Follow the pre-operation checklist, maintenance and operating instructions in this manual.

Install, calibrate and operate the spray controller according to the spray controller operators manual.

Inspections of the Flowmeter should be performed regularly.

#### Daily Check & Maintenance of Flowmeter

This is to be performed every day after work is finished:

- Unscrew the assembly that holds the Rapid Check unit in the body.
- Remove the Rapid Check unit from the body.

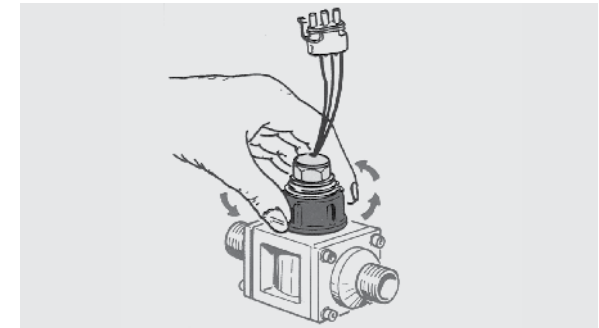

Unscrew the Rapid Check assembly

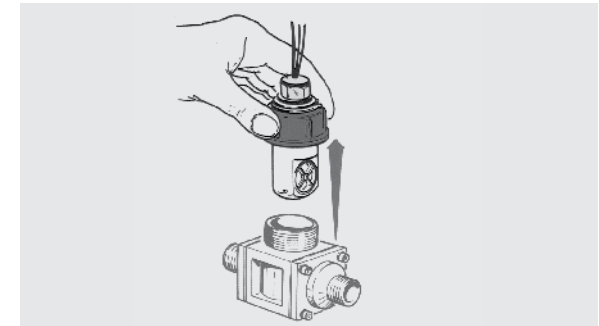

Remove the Rapid Check unit

- Use clean water to wash any impurities out of the removable turbine unit.

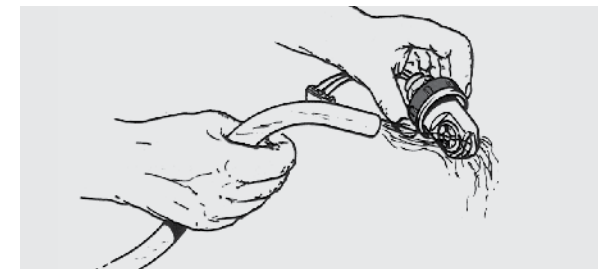

Wash any impurities out of the removable turbine unit

# SECTION 6H

## SPRAYING INFORMATION - HORTICULTURE

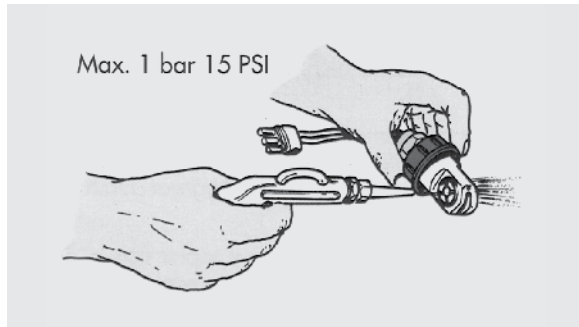

Use compressed air to check that the turbine unit rotates freely

4. Use compressed air to verify that the turbine unit rotates freely (maximum air pressure 1 BAR [15 psi]).

### Every 50 Hours

Carry out the following procedure after every 50 hours of operation:

1. Unscrew the sensor.

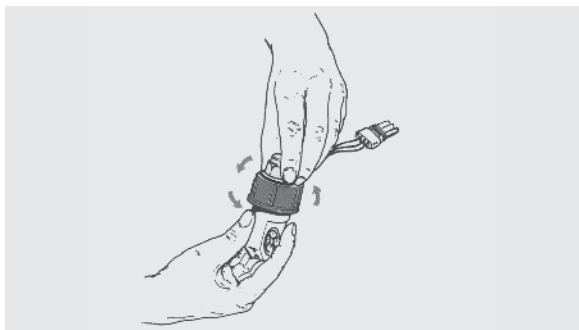

2. Separate the sensor from the Rapid Check unit.

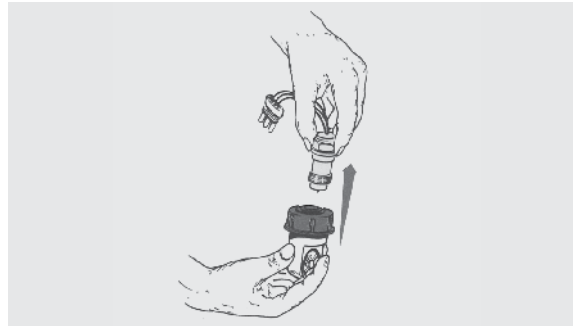

Separate the sensor from the Rapid Check unit

3. Place the Rapid Check unit in a detergent bath for a few hours.

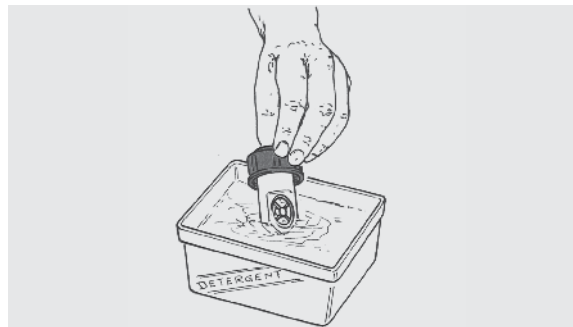

Place the Rapid Check unit in a detergent bath

4. Remove the Rapid Check unit from detergent bath.  
Use compressed air to verify that the turbine unit rotates freely (maximum air pressure 1 BAR [15 psi]).  
If necessary, replace the Rapid Check unit with a new one.

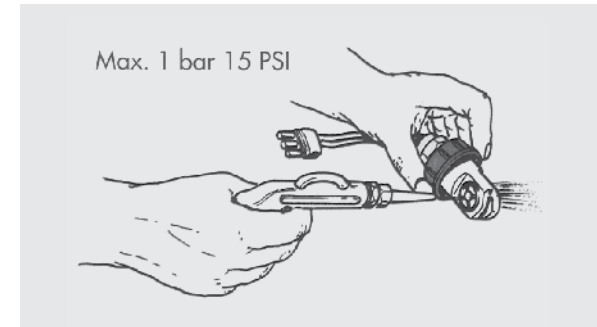

Use compressed air to check that the turbine unit rotates freely

# SECTION 6H

## SPRAYING INFORMATION - HORTICULTURE

### STEP 2 - DETERMINING THE ACTUAL SPEED OF TRAVEL

If optioned with auto rate controller, your sprayer has been factory set with a calibration number. This should be fine tuned prior to commencement of spraying and checked by your dealer. This is done by traveling a known distance (usually 100 metres) and comparing the distance measured by the Spray Controller to the known distance. If there is a discrepancy, the Spray Controller Manual explains how to easily adjust the calibration number automatically.

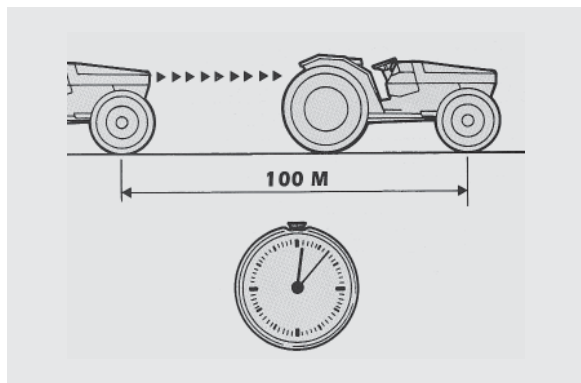

To manual check the speed...

- Half fill the sprayer tank with water and mark out a test strip of 100 metres (simulating spraying conditions).
- Set the sprayer operating and record the time taken to travel 100 metres at your required spraying speed.

c) Calculate the actual speed of travel using the formula:

**For SPEED, km/hr** = using the following formula:

$$\frac{\text{Distance (m)} \times 3.6}{\text{Time (sec)}}$$

eg.  $100(\text{m}) \times 3.6 \div 48(\text{seconds})$   
 $= 7.5\text{km/hr}$  travel speed

An alternative formula is:

$$\text{km/hr} = \text{Metres travelled in 1 minute}$$

### STEP 3 - DETERMINE SPRAYING VOLUME REQUIRED

It is essential to determine the liquid volume per hectare required to effectively spray a crop without overspraying or underspraying.

The spray volume requirement should be determined by / in conjunction with an agronomist / spray manager / someone skilled in the art of spraying.

The term "litres per hectare" must be related to foliage and not just to land area. The amount of liquid needed to effectively spray any given crop will vary greatly with:

- The type of crop
- Row spacing
- Width of canopy
- Height of canopy
- Stage of growth
- Density of foliage

- Type of leaf surface
- Type of fruit (single or bunched)
- Type of sprayer used

### STEP 4 - DETERMINE SPRAYER CONFIGURATION

Once the volume of required spray volume per hectare is established, the next step in setting up the sprayer is to determine:

- The **number of row(s)** to be sprayed in one pass, and
- The **total number of nozzles** to be used on the sprayer. Don't forget Tier 1, Tier 2 and Tier 3 options.

Both these factors can vary with the model of sprayer used and other factors mentioned under step 3.

#### Example A

A 2-row QM-420 Sprayer to spray vines – using 2 spray fans per Fan Frame, will give a total of 8 spray fans. Each spray fan has 2 spray rings - each with 5 nozzles per ring. That gives a combined total of 40 nozzles per (8 spray rings x 5) per Tier/80 nozzles (both spray sets of rings combined) to spray two rows per pass.

#### Example B

A 3-row QM-420 Sprayer to spray vines – using 3 spray fans per Fan Frame, will give a total of 18 spray fans. Each spray fan has 2 spray rings - each with 5 nozzles per ring. That gives a combined total of 90 nozzles per (18 spray rings x 5) per Tier/180 nozzles (both spray sets of rings combined) to spray two rows per pass.

The choice of nozzles (step 5 below) will influence decisions regarding the Sprayer's Tier configuration.

# SECTION 6H

## SPRAYING INFORMATION - HORTICULTURE

### STEP 5 - DETERMINE THE IDEAL SPRAY PRESSURE

Before determining the correct nozzles, it's best to have an idea of the spray pressure required. As a general rule, a pressure of 5 to 10 bar is considered ideal. Setting up the sprayer around a pressure of say 7 to 8 bar will allow lower pressures (say 5 or 6 bar) to be used in early season and higher pressure (say 9 or 10 bar) for later season without having to change nozzles mid-season. It will also offer some margin around travelling slower or faster than the chosen speed.

The advice provided above is general information only and operators should seek specialised advice from their agronomist/spray manager/someone skilled in the art of spraying.

**NOTE; when determining the optimum nozzles for both spray rings (Tiers 1 & 2), all calculations should be done at the same pressure.**

### STEP 6 - DETERMINE & SELECT CORRECT NOZZLES

Knowing actual travel speed, application rate required, number of rows to be sprayed in one pass, total number of nozzles to be used and ideal spray pressure, we can determine the nozzles required for the sprayer.

The calculation formulation is;

$$\frac{\text{Litres/Minute/Nozzle}}{\text{(Litres per minute per nozzle)}} = \frac{\text{Litres/Ha} \times \text{Km/hr} \div 600}{\text{total number of nozzles used} \times \text{row spacing (m)} \times \text{number of rows in one pass}}$$

## CROPLANDS

### Quantum Mist ALBUZ Nozzle Selection Worksheet

#### Step 1:

Enter data in grey boxes

| Formula            |                                  |                |                                  |
|--------------------|----------------------------------|----------------|----------------------------------|
| Target rate (L/ha) | <input type="text" value="650"/> | Speed (km/hr)  | <input type="text" value="7.5"/> |
| Row spacing (m)    | <input type="text" value="3"/>   | Number of rows | <input type="text" value="1"/>   |
| Number of nozzles  | <input type="text" value="40"/>  |                |                                  |
| Total L/min =      |                                  | <b>24.375</b>  | L/min per nozzle                 |
|                    |                                  |                | <b>0.61</b>                      |

#### Step 2:

Select nozzles from chart

| ALBUZ NOZZLE | PART NUMBER   | MESH | 5 Bar | 6 Bar | 7 Bar       | 8 Bar | 9 Bar |
|--------------|---------------|------|-------|-------|-------------|-------|-------|
| WHITE        | AZ-ATR-WE-80C | 100  | 0.27  | 0.29  | 0.32        | 0.34  | 0.36  |
| LILAC        | AZ-ATR-LC-80C | 50   | 0.36  | 0.39  | 0.42        | 0.45  | 0.48  |
| BROWN        | AZ-ATR-BN-80C | 50   | 0.48  | 0.52  | <b>0.56</b> | 0.60  | 0.64  |
| YELLOW       | AZ-ATR-YW-80C | 50   | 0.73  | 0.80  | 0.86        | 0.92  | 0.97  |
| ORANGE       | AZ-ATR-OE-80C | 50   | 0.99  | 1.08  | 1.17        | 1.24  | 1.32  |
| RED          | AZ-ATR-RD-80C | 50   | 1.38  | 1.51  | 1.62        | 1.73  | 1.83  |
| GREY         | AZ-ATR-GY-80C | 50   | 1.5   | 1.63  | 1.76        | 1.87  | 1.98  |
| GREEN        | AZ-ATR-GN-80C | 50   | 1.78  | 1.94  | 2.09        | 2.22  | 2.35  |
| BLACK        | AZ-ATR-BK-80C | 50   | 2     | 2.18  | 2.35        | 2.50  | 2.64  |
| BLUE         | AZ-ATR-BE-80C | 50   | 2.45  | 2.67  | 2.87        | 3.06  | 3.24  |

**NOTE; it's easiest to make the calculations based on each individual spray ring volume and then combine both rings. Always select nozzles from same pressure.**

For example, using Example A from the previous pages ....

- Row spacing = 3.0m
- Number of rows = 2
- Number of nozzles = 40
- Speed = 7.5 kph
- Ideal pressure 7 ~ 8 bar
- Tier 1 target rate = 300 L/ha
- Tier 2 target rate = 450 L/ha
- Tier 3 target rate = 750 L/ha

Using the above formula ....

**300** (target rate) x **7.5** (speed) ÷ 600 ÷ **40** (number of nozzles) x **3.0** (row spacing) x **2** (no. of rows) = **0.56** Litres per minute per nozzle.

Once the flow rate per nozzle is known select the most appropriate nozzle from a flowrate chart for the nozzle being used. Flowrate charts are available from relevant nozzle suppliers. Croplands supplies and recommends the ALBUZ ATR Hollow Cone Nozzles for the Quantum Mist Sprayers.

Pictured left and overleaf are screenshots taken from a small spreadsheet program freely available from the Croplands Web Site or Croplands Customer Service titled "ALBUZ QM Nozzle Selection Worksheet" which makes it much quicker to calculate nozzle requirements. For more nozzles see the Croplands Optima buyers guide.



# SECTION 6H

## SPRAYING INFORMATION - HORTICULTURE

In the example on previous page the **correct nozzle** for Tier 1 is the ALBUZ Brown operating at 7 Bar.

In the sample below, the **correct nozzle** for Tier 2 is the ALBUZ Yellow operating at 7 bar. Note the formula requires 0.84 L/min, and the nozzle flowchart shows 0.86 L/min. This nozzle with a marginal decrease in pressure will meet our requirements.

### CROPLANDS

#### Quantum Mist ALBUZ Nozzle Selection Worksheet

##### Step 1:

Enter data in grey boxes

| Formula            |        |
|--------------------|--------|
| Target rate (L/ha) | 650    |
| Speed (km/hr)      | 7.5    |
| Row spacing (m)    | 3      |
| Number of rows     | 1      |
| Number of nozzles  | 40     |
| Total L/min =      | 24.375 |
| L/min per nozzle   | 0.61   |

##### Step 2:

Select nozzles from chart

| ALBUZ NOZZLE | PART NUMBER   | MESH | 5 Bar | 6 Bar | 7 Bar | 8 Bar | 9 Bar |
|--------------|---------------|------|-------|-------|-------|-------|-------|
| WHITE        | AZ-ATR-WE-80C | 100  | 0.27  | 0.29  | 0.32  | 0.34  | 0.36  |
| LILAC        | AZ-ATR-LC-80C | 50   | 0.36  | 0.39  | 0.42  | 0.45  | 0.48  |
| BROWN        | AZ-ATR-BN-80C | 50   | 0.48  | 0.52  | 0.56  | 0.60  | 0.64  |
| YELLOW       | AZ-ATR-YW-80C | 50   | 0.73  | 0.80  | 0.86  | 0.92  | 0.97  |
| ORANGE       | AZ-ATR-OE-80C | 50   | 0.99  | 1.08  | 1.17  | 1.24  | 1.32  |
| RED          | AZ-ATR-RD-80C | 50   | 1.38  | 1.51  | 1.62  | 1.73  | 1.83  |
| GREY         | AZ-ATR-GY-80C | 50   | 1.5   | 1.63  | 1.76  | 1.87  | 1.98  |
| GREEN        | AZ-ATR-GN-80C | 50   | 1.78  | 1.94  | 2.09  | 2.22  | 2.35  |
| BLACK        | AZ-ATR-BK-80C | 50   | 2     | 2.18  | 2.35  | 2.50  | 2.64  |
| BLUE         | AZ-ATR-BE-80C | 50   | 2.45  | 2.67  | 2.87  | 3.06  | 3.24  |

Across the spraying season the variables (such as rates and speeds) may often change. With a well setup system small variations will be easily accommodated. Larger variations may require a change of nozzles.

### STEP 7 - FIT & TEST SELECTED NOZZLES

The most important calibration is to test for the actual litres per hectare achieved through your sprayer.

- Use the following method to fit and test the selected nozzles:
- Fit selected nozzles to the sprayer.
- Fill your spray tank to maximum capacity & set the specified pump pressure and operate the sprayer for a short period to make sure all lines are full and nozzles are working properly (no blockages, leaks etc).
- Stop the sprayer and top up the tank with water to maximum capacity again.
- Operate the sprayer in the stationary position at the required pressure for not less than one minute.
- Measure how much water is required to refill the tank to the brim.
- Now, divide the volume measured by the time taken (minutes). The longer the test time the more accurate the figure.

The calculation formulation is;

Output (L/min) =

$$\frac{\text{Output (litres)}}{\text{Time (minutes)}}$$

### Example 1, testing Tier 1 of our examples above.

$$\frac{28.5 \text{ litres}}{1.25 \text{ minutes (75 seconds)}} = 22.8 \text{ litres/min.}$$

Which is slightly more than the target of 22.4L/min (0.56 L/min per nozzle x 40 nozzles for 1.0 min)

### Example 2, testing Tier 2 of our examples above.

$$\frac{42.1 \text{ litres}}{1.25 \text{ minutes (75 seconds)}} = 33.7 \text{ litres/min.}$$

(note 0.86 L/min per nozzle x 40 nozzles for 1.0 min = 34.4 L/min)

- Excessive output is a sign of worn nozzles. See steps 8 & 9.
- Insufficient output is a sign of blockages. See steps 8 & 9.

### STEP 8 - CALCULATE THE ACTUAL APPLICATION RATE

Actual application rate is the objective of setting up and calibrating your sprayer.

# SECTION 6H

## SPRAYING INFORMATION - HORTICULTURE

To calculate actual application rate (litres per hectare), use the following formula:

$$\text{Application Rate (L/ha)} = \frac{\text{Total sprayer output (L/min)} \times 600 \div \text{speed (Km/hr)} \div \text{row spacing (m)} \div \text{number rows in one pass}}{}$$

**Example 1** (as per Tier 1 example)

$$\frac{22.8 \text{ (L/min)} \times 600 \div 7.5 \text{ km/hr} \div 3 \text{ m (row spacing)} \div 2 \text{ (rows/pass)}}{=} = 304 \text{ litres/ha}$$

**Example 2** (as per Tier 2 example)

$$\frac{33.7 \text{ (L/min)} \times 600 \div 7.5 \text{ km/hr} \div 3 \text{ m (row spacing)} \div 2 \text{ (rows/pass)}}{=} = 449 \text{ litres/ha.}$$

### STEP 9 - IF THE TESTED RATE IS UNSATISFACTORY

If your tested application rate does not meet your requirements, your options are:

#### A) In Auto mode - if the application rate is not being achieved:

- Operating pressure will be excessive if nozzles are too small or blocked or speed is too fast.

Likewise, if your pressure filter is blocked (even partially), you may experience excessive pressure at the pump.

Make adjustments accordingly.

- Operating pressure will fall if nozzles are too large or speed is too slow. Make adjustments accordingly.

#### B) In Manual mode - the Controller application rate can be altered by:

- Adjusting pressure up or down to increase or decrease rate of application (use +/- keys).
- Adjusting spraying speed up or down to decrease or increase rate of application.

- Changing to a different nozzle capacity.

Repeat necessary testing procedures and calculation of application rate if adjustments or changes are made

#### LITRES PER 100 METRES / ROW

Many Auto Rate controllers have an option for Litres per 100 metres and is occasionally the unit of preference in some vineyard operations. It's a simpler formula as row width is not relevant.

The calculation requires volume and distance, such as 11 litres per 100 metres (of rows). The operator only needs to follow the chemical label rate for mixing concentrate per 100 L.

| Litres / Hectare conversion to Litres/100m |     |                      |      |      |      |      |      |      |      |      |      |      |      |      |      |      |      |      |      |      |      |      |
|--|-----|----------------------|------|------|------|------|------|------|------|------|------|------|------|------|------|------|------|------|------|------|------|------|
| Table unit = L/100 m                       |     |                      |      |      |      |      |      |      |      |      |      |      |      |      |      |      |      |      |      |      |      |      |
|  |     | Row Spacing (metres) |      |      |      |      |      |      |      |      |      |      |      |      |      |      |      |      |      |      |      |      |
|  |     | 2.0                  | 2.1  | 2.2  | 2.3  | 2.4  | 2.5  | 2.6  | 2.7  | 2.8  | 2.9  | 3    | 3.1  | 3.2  | 3.3  | 3.4  | 3.5  | 3.6  | 3.7  | 3.8  | 3.9  | 4.00 |
| Litres/Hectare                             | 250 | 5.0                  | 5.3  | 5.5  | 5.8  | 6.0  | 6.3  | 6.5  | 6.8  | 7.0  | 7.3  | 7.5  | 7.8  | 8.0  | 8.3  | 8.5  | 8.8  | 9.0  | 9.3  | 9.5  | 9.8  | 10.0 |
|  | 300 | 6.0                  | 6.3  | 6.6  | 6.9  | 7.2  | 7.5  | 7.8  | 8.1  | 8.4  | 8.7  | 9.0  | 9.3  | 9.6  | 9.9  | 10.2 | 10.5 | 10.8 | 11.1 | 11.4 | 11.7 | 12.0 |
|  | 350 | 7.0                  | 7.4  | 7.7  | 8.1  | 8.4  | 8.8  | 9.1  | 9.5  | 9.8  | 10.2 | 10.5 | 10.9 | 11.2 | 11.6 | 11.9 | 12.3 | 12.6 | 13.0 | 13.3 | 13.7 | 14.0 |
|  | 400 | 8.0                  | 8.4  | 8.8  | 9.2  | 9.6  | 10.0 | 10.4 | 10.8 | 11.2 | 11.6 | 12.0 | 12.4 | 12.8 | 13.2 | 13.6 | 14.0 | 14.4 | 14.8 | 15.2 | 15.6 | 16.0 |
|  | 450 | 9.0                  | 9.5  | 9.9  | 10.4 | 10.8 | 11.3 | 11.7 | 12.2 | 12.6 | 13.1 | 13.5 | 14.0 | 14.4 | 14.9 | 15.3 | 15.8 | 16.2 | 16.7 | 17.1 | 17.6 | 18.0 |
|  | 500 | 10.0                 | 10.5 | 11.0 | 11.5 | 12.0 | 12.5 | 13.0 | 13.5 | 14.0 | 14.5 | 15.0 | 15.5 | 16.0 | 16.5 | 17.0 | 17.5 | 18.0 | 18.5 | 19.0 | 19.5 | 20.0 |
|  | 550 | 11.0                 | 11.6 | 12.1 | 12.7 | 13.2 | 13.8 | 14.3 | 14.9 | 15.4 | 16.0 | 16.5 | 17.1 | 17.6 | 18.2 | 18.7 | 19.3 | 19.8 | 20   | 21   | 21   | 22   |
|  | 600 | 12.0                 | 12.6 | 13.2 | 13.8 | 14.4 | 15.0 | 15.6 | 16.2 | 16.8 | 17.4 | 18.0 | 18.6 | 19.2 | 19.8 | 20   | 21   | 22   | 22   | 23   | 23   | 24   |
|  | 650 | 13.0                 | 13.7 | 14.3 | 15.0 | 15.6 | 16.3 | 16.9 | 17.6 | 18.2 | 18.9 | 19.5 | 20   | 21   | 21   | 22   | 23   | 23   | 24   | 25   | 25   | 26   |
|  | 700 | 14.0                 | 14.7 | 15.4 | 16.1 | 16.8 | 17.5 | 18.2 | 18.9 | 19.6 | 20   | 21   | 22   | 22   | 23   | 24   | 25   | 25   | 26   | 27   | 27   | 28   |
|  | 750 | 15.0                 | 15.8 | 16.5 | 17.3 | 18.0 | 18.8 | 19.5 | 20   | 21   | 22   | 23   | 23   | 24   | 25   | 26   | 26   | 27   | 28   | 29   | 29   | 30   |
|  | 800 | 16.0                 | 16.8 | 17.6 | 18.4 | 19.2 | 20   | 21   | 22   | 22   | 23   | 24   | 25   | 26   | 26   | 27   | 28   | 29   | 30   | 30   | 31   | 32   |
|  | 850 | 17.0                 | 17.9 | 18.7 | 19.6 | 20   | 21   | 22   | 23   | 24   | 25   | 26   | 26   | 27   | 28   | 29   | 30   | 31   | 31   | 32   | 33   | 34   |
|  | 900 | 18.0                 | 18.9 | 19.8 | 21   | 22   | 23   | 23   | 24   | 25   | 26   | 27   | 28   | 29   | 30   | 31   | 32   | 32   | 33   | 34   | 35   | 36   |
|  | 950 | 19.0                 | 20   | 21   | 22   | 23   | 24   | 25   | 26   | 27   | 28   | 29   | 29   | 30   | 31   | 32   | 33   | 34   | 35   | 36   | 37   | 38   |
| 1000                                       | 20  | 21                   | 22   | 23   | 24   | 25   | 26   | 27   | 28   | 29   | 30   | 31   | 32   | 33   | 34   | 35   | 36   | 37   | 38   | 39   | 40   |      |
| 1100                                       | 22  | 23                   | 24   | 25   | 26   | 28   | 29   | 30   | 31   | 32   | 33   | 34   | 35   | 36   | 37   | 39   | 40   | 41   | 42   | 43   | 44   |      |
| 1200                                       | 24  | 25                   | 26   | 28   | 29   | 30   | 31   | 32   | 34   | 35   | 36   | 37   | 38   | 40   | 41   | 42   | 43   | 44   | 46   | 47   | 48   |      |
| 1300                                       | 26  | 27                   | 29   | 30   | 31   | 33   | 34   | 35   | 36   | 38   | 39   | 40   | 42   | 43   | 44   | 46   | 47   | 48   | 49   | 51   | 52   |      |
| 1400                                       | 28  | 29                   | 31   | 32   | 34   | 35   | 36   | 38   | 39   | 41   | 42   | 43   | 45   | 46   | 48   | 49   | 50   | 52   | 53   | 55   | 56   |      |
| 1500                                       | 30  | 32                   | 33   | 35   | 36   | 38   | 39   | 41   | 42   | 44   | 45   | 47   | 48   | 50   | 51   | 53   | 54   | 56   | 57   | 59   | 60   |      |

# SECTION 6H

## SPRAYING INFORMATION - HORTICULTURE

Flowrate conversion charts are available in the Nufarm SprayWise Horticultural application handbook and the Croplands Optima spray range buyers guide.

**Example 1** (as per Tier 1 example)

Using the chart above, 300 Lt / ha x 3m rows correlates to 9 litres per 100 metres of row.

### STEP 10 - COVERAGE ASSESSMENT

Operate your sprayer in the required orchard or vineyard to check the actual spray coverage achieved on foliage.

This is important because it is the only real measure you have of actual coverage and effective penetration of your sprayer.

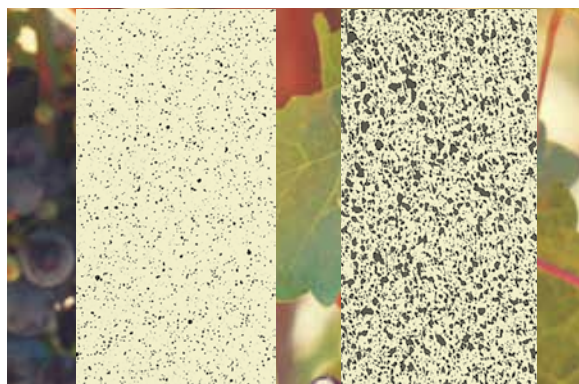

Coverage checks can be done using:

- Water Sensitive Papers (as pictured) and available through Croplands dealers – see Croplands Optima Buyers guide for further details.

- Clay Markers as available through Croplands dealers – see Croplands Optima Buyers guide for further details.
- Fluorescent Dye system as available through Croplands dealers – see Croplands Optima Buyers guide for further details.

It is recommended to test the unit using water only as a test run, and again when applying your chemical mixture.

Ensure water sensitive papers are strategically placed on both upper and lower surfaces.

Spray testing, evaluation and adjustment to the sprayer (say fan positions) or spray settings (say nozzles, pressures and rates) should be done in conjunction with an agronomist / spray manager / someone skilled in the art of spraying. The best setup might vary significantly from crop to crop, season to season etc.

### STEP 11 - ADD THE CORRECT AMOUNT OF CHEMICAL TO THE TANK

**For land area rates (Litres or kg per hectare)**

Use the following formula:

$$\text{Chemical required (Litres) =} \\ \frac{\text{Tank volume (Litres) x} \\ \text{recommended chemical rate (L/ha)}}{\text{spray application rate (L/ha)}}$$

For example;

$$\frac{2000 \text{ (litre tank) x } 2.0 \text{ (chemical rate L/ha)}}{50 \text{ (spray application rate L/ha)}} \\ = 80 \text{ litres of chemical}$$

**If chemical recommendation is given in water volume rates**

Use the following formula:

$$\text{Chemical required (Litres) =} \\ \frac{\text{Tank volume (Litres) x} \\ \text{recommended chemical rate (L/100 litres)}}{100}$$

For example;

$$\frac{2000 \text{ (litre tank) x } 4 \text{ (chemical rate L/100 litres)}}{100} = 80 \text{ litres of chemical}$$

**For tank volume required,**

Use the following formula:

$$\text{Tank volume required (Litres) =} \\ \text{Area (ha) x spray application rate (L/ha)}$$

# SECTION 6H

## SPRAYING INFORMATION - HORTICULTURE

For example;

20 (hectares) x 50 (application rate, L/ha)  
= 1000 litres of spray tank capacity required

### STEP 12 - RECORD ALL DATA FOR FUTURE REFERENCE

Record all your calibration data on the work sheets given at the end of this section.

Photocopy the work sheets to obtain the number of work sheets required.



### ALBUZ-ATR HOLLOW CANE NOZZLES

#### Features:

- Angle of 80° at 5 bar
- Easy dismantling for cleaning
- Hollow cone nozzle producing fin droplets
- AlbuZ durable pink ceramic allows precision high pressure spraying
- Polished ceramics ensure perfect sealing and precise flow rate.

#### Applications:

- For fungicides and insecticides
- Recommended for orchards and vineyards.

|                         | ALBUZ NOZZLE | PART NUMBER   | MESH | 5 BAR | 6 BAR | 7 BAR | 8 BAR | 9 BAR | 10 BAR | 11 BAR | 12 BAR |
|-------------------------|--------------|---------------|------|-------|-------|-------|-------|-------|--------|--------|--------|
|                         | WHITE        | AZ-ATR-WE-80C | 100  | 0.27  | 0.29  | 0.32  | 0.34  | 0.36  | 0.38   | 0.39   | 0.41   |
|                         | LILAC        | AZ-ATR-LC-80C | 50   | 0.36  | 0.39  | 0.42  | 0.45  | 0.48  | 0.50   | 0.52   | 0.55   |
| <b>CURRENT STANDARD</b> | BROWN        | AZ-ATR-BN-80C | 50   | 0.48  | 0.52  | 0.56  | 0.60  | 0.64  | 0.67   | 0.70   | 0.73   |
| <b>CURRENT STANDARD</b> | YELLOW       | AZ-ATR-YW-80C | 50   | 0.73  | 0.80  | 0.86  | 0.92  | 0.97  | 1.03   | 1.07   | 1.12   |
|                         | ORANGE       | AZ-ATR-OE-80C | 50   | 0.99  | 1.08  | 1.17  | 1.24  | 1.32  | 1.39   | 1.45   | 1.51   |
|                         | RED          | AZ-ATR-RD-80C | 50   | 1.38  | 1.51  | 1.62  | 1.73  | 1.83  | 1.92   | 2.01   | 2.09   |
|                         | GREY         | AZ-ATR-GY-80C | 50   | 1.50  | 1.63  | 1.76  | 1.87  | 1.98  | 2.08   | 2.17   | 2.26   |
|                         | GREEN        | AZ-ATR-GN-80C | 50   | 1.78  | 1.94  | 2.09  | 2.22  | 2.35  | 2.47   | 2.58   | 2.69   |
|                         | BLACK        | AZ-ATR-BK-80C | 50   | 2.00  | 2.18  | 2.35  | 2.50  | 2.64  | 2.78   | 2.90   | 3.03   |
|                         | BLUE         | AZ-ATR-BE-80C | 50   | 2.45  | 2.67  | 2.87  | 3.06  | 3.24  | 3.40   | 3.56   | 3.71   |

# SECTION 6H

## SPRAYING INFORMATION - HORTICULTURE

### CALIBRATION WORK SHEET

#### Step 1

Check the Sprayer is in Good Working Order

#### Step 2

##### Determine Actual Speed of Travel

Measure and mark a straight path of 100 metres (or more) of travelling conditions similar to the orchard or vine yard you are going to spray.

Half fill the spray tank & record the time (in seconds) to travel the measured distance.

Make sure that the tractor is travelling at spraying speed when you pass the start and finish marks and ensure the fan and pump are at operational speed.

If you have a hectare metre or automatic controller you need to check the speed calibration of the controller.

|               |  |
|---------------|--|
| Tractor model |  |
| Gear          |  |
| Range         |  |
| Dual power    |  |
| Engine RPM    |  |
| Speed in Km/h |  |

**Kilometres per Hour = Distance traveled (m) x 3.6**

#### Step 3

##### Determine Spraying Volume Required

It is essential to determine the liquid volume per hectare required to effectively spray a crop without overspraying or underspraying.

Use your own experience or a registered rate calibration consultant to determine effective volume in litres per hectare.

..... litres/ha

#### Step 4

##### Determine Sprayer Configuration

Number of row(s) to be sprayed in one pass

Total number of nozzles to be used:

#### Step 5

##### Determine & Select Nozzles

Determine nozzle flow rate required:

**Litres/Minute/Nozzle**

=

**Litres/Ha x Km/hr ÷ 600 ÷ Total  
Number of Nozzles Used x Row  
Spacing (m) x Number of Rows in  
One Pass**

$$\text{[ ]} \times \text{[ ]} \div 600 \div \text{[ ]} \times \text{[ ]} \times \text{[ ]}$$

$$= \text{[ ]} \text{ litres/minute/nozzle}$$

Once the flow rate per nozzle is known, select an appropriate nozzle size from the nozzle charts [see pages 4.9-4.11].

Nozzle Selection

#### Step 6

##### Fit & Test Selected Nozzles

The most important calibration is to test for **actual litre per hectare**. Fill your spray tank to overflowing and run the sprayer for one minute, at the above operating settings, and record the total litres per minute used.

**Output/min (l/min)**

=

**Output (litres) ÷ Time (minutes)**

$$\text{[ ]} \div \text{[ ]} = \text{[ ]} \text{ litres/min}$$

#### Step 7

##### Calculate the Actual Application Rate

To calculate actual application rate (litres per hectare), use the following formula::

**Application Rate (l/ha)**

=

**Total Sprayer Output (l/min) x 600  
÷ Speed (Km/hr) ÷ Row Spacing (m)  
÷ Number Rows in One Pass**

$$\text{[ ]} \times 600 \div \text{[ ]} \div \text{[ ]} \div \text{[ ]}$$

$$= \text{[ ]} \text{ litres/ha}$$

#### Record your data:

|                        |  |
|------------------------|--|
| Farm location          |  |
| Crop to be sprayed     |  |
| Canopy width (m)       |  |
| Canopy Height (m)      |  |
| Spray Volume litres/ha |  |
| No. Rows in one pass   |  |
| No. of nozzles used    |  |
| Litres/minute/nozzle   |  |
| Nozzle pressure        |  |
| Nozzle type            |  |
| Nozzle size & colour   |  |
| Tested Output in l/min |  |
| Actual Litres/Hectare  |  |
|                        |  |
|                        |  |

Note: If your sprayer has a flow meter fitted, you should calibrate it regularly. The calibration setting on the tag is a factory setting only and needs to be regularly checked - taking into consideration changes in density and/or viscosity of the product to be sprayed.

# SECTION 7

## LUBRICATION & MAINTENANCE

### NOTE

This GENERAL manual is a generic overview to a variety of spray operations. It contains information relating to Broadacre and/or Horticulture operations. Some features and options explained in this manual may not be installed on your sprayer.

|  |           |
|--|-----------|
| <b>GREASING &amp; SERVICE PROCEDURES</b>     | <b>47</b> |
| <b>GREASE POINT DIAGRAMS</b>                 | <b>48</b> |
| <b>PUMPS</b>                                 | <b>49</b> |
| <b>DIAPHRAGMS, STRAPS &amp; FOAM MARKERS</b> | <b>50</b> |

# SECTION 7

## LUBRICATION & MAINTENANCE

### GREASING & SERVICE PROCEDURES

1. Clean suction line filter with each tank load.
2. Clean pressure line filter.
3. Check nozzle filters.
4. Check tyre pressure and check wheel nuts, if applicable.

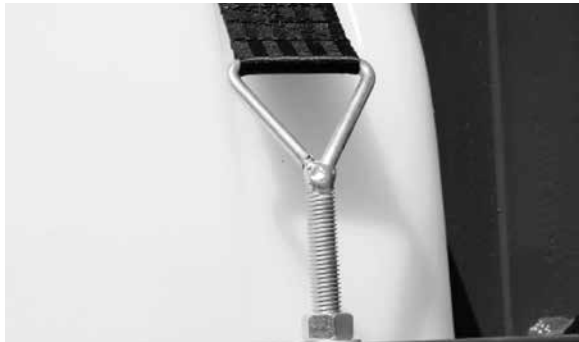

Check the tank straps

5. Check flush tank straps and tighten if necessary.
6. Clean Rapid-check flowmeter, if fitted.



Clean the Rapid Check Flowmeter (if fitted)

7. Grease tractor to sprayer PTO universal joints every 8 hours.  
Grease lightly until grease becomes firm in seals.

Over greasing will break seals and allow dust and moisture to penetrate - increasing wear.



Grease the jack (if fitted)

8. Grease PTO inner tubes every 8 hours.  
To lubricate the inner tube, slide PTO shaft apart, clean the telescopic tubes, grease and reassemble.
9. Grease the PTO covers every 20 hours.
10. Check pump air chamber pressure on a regular basis.  
As a general guideline it should be 10%-20% of operating pressure (70-100 kPa [10-15 psi]).
11. To ensure trouble free spraying, flush the sprayer with fresh water thoroughly each day, and before changing chemicals. Dispose of tank wash according to chemical manufacturers instructions.



Repack the wheel bearings at 200 hours

12. Grease all boom joints, height adjuster points and other grease points.
13. Grease the jack, if fitted.

### Every 200 Hours

1. Lubricate quick release lock pins on PTO shaft.
2. Re-pack wheel bearings with grease.
3. Inspect the bushes & pins on the tandem axle (if fitted).
4. Change air filter for foam marker.
5. Fully flush foam marker.
6. Grease all tank lid seals with vaseline.

## NOTE

**Ensure the sliding inner tubes of the PTO are greased every 8 hours (working around the clock equals 3 times/day), especially when doing a lot of tight turning.**

# SECTION 7

## LUBRICATION & MAINTENANCE

### GREASE POINT DIAGRAMS

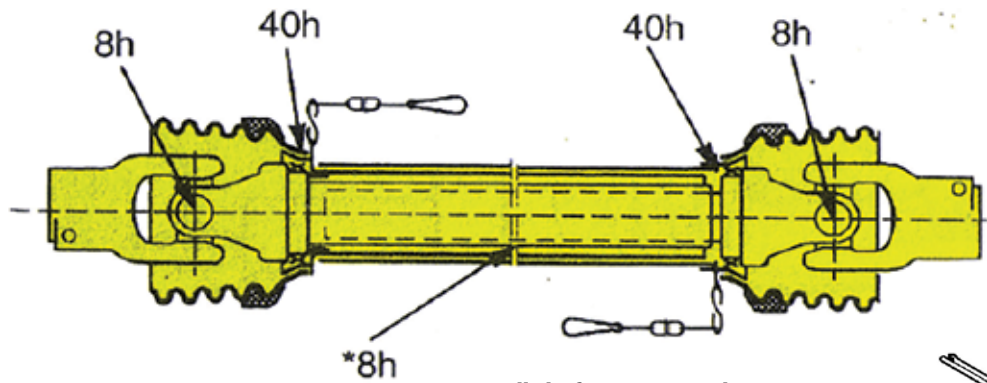

PTO Grease Points

Pull shaft apart - apply grease to inside of outer telescopic profile

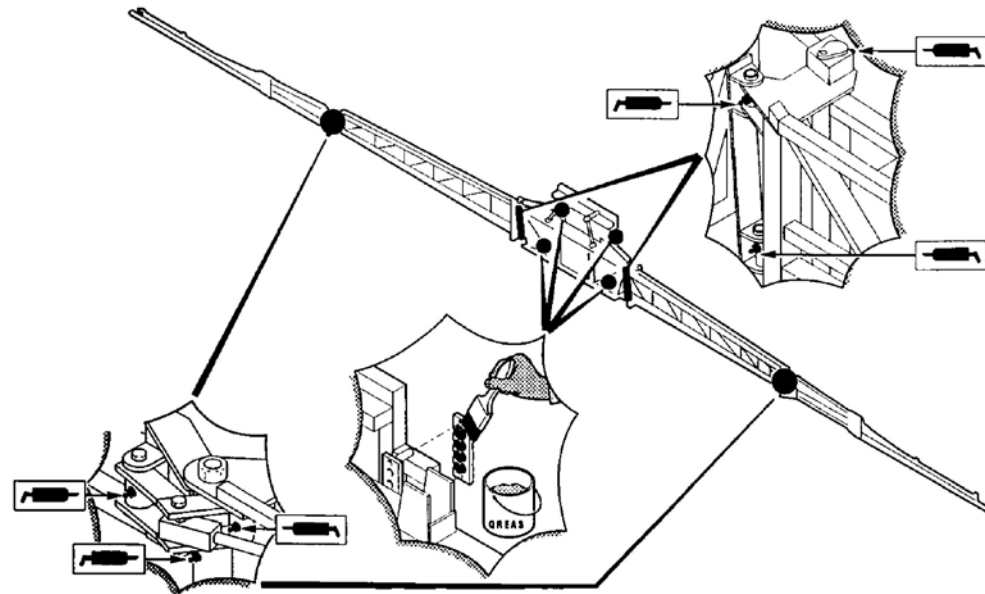

Boom Grease Points



# SECTION 7

## LUBRICATION & MAINTENANCE

### PUMPS

#### Diaphragm Pump Maintenance

Annovi & Reverberi (A&R) pumps are of the piston-diaphragm type. All parts in contact with the spray liquid, which are subject to corrosion, are protected, making them ideal for spraying (herbicides, insecticides, fungicides, fertilisers, etc.), disinfection and washing.

#### Daily Before Starting the Pump

1. Check that oil is visible in sight glass (between minimum and maximum level indicators) and top up, if necessary, with good clean motor oil 20W/30 or 20W/40.
2. Clean all sprayer filters. Blocked or semi blocked filters place extra stress on diaphragms.
3. Start with zero pressure and the pump will self prime immediately.

#### Daily after Use

1. Flush pump with clean water.
2. Drain filters and clean. A high percentage of pump failures are due to blocked filters.

#### Every 50 Hours

Check surge chamber pressure and adjust as follows:

- Air pressure 70-100kPa (10- 15psi) [Should be 10-20% of operating pressure].

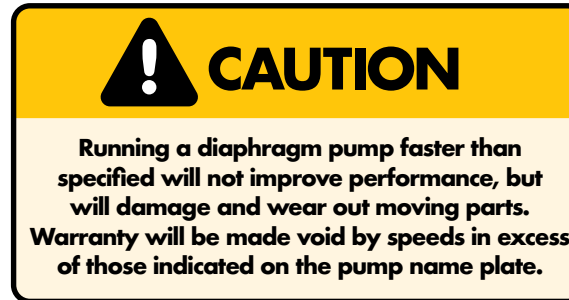

Vibration of the delivery hose usually indicates that the air pressure in the surge chamber is incorrect.

The main cause of surge chamber diaphragm fracture is low pressure in this chamber.

Surge chamber pressure can be checked with an ordinary tyre gauge.

The above pressure range is a guide to the correct pressure.

However, if difficulties recur, adjust the pressure until an even flow is obtained from the pump (no pulsing of liquid at operating RPM). The pressure is best increased with a bicycle pump.

#### Every 250 hours or Every Season - Whichever Comes Sooner

1. Change oil and refill with 20W/30 oil.  
Attention should be made to remove trapped air behind the diaphragms by rocking from side to side as instructed.

It is also good practise to run the pump for 10 minutes without pressure, and then, top up with oil before working the pump.

2. When changing the pump oil, check diaphragms and replace them if they are showing signs of wear.

This is normally a pre-season maintenance procedure which can be done easily as no special tools are required.

You can avoid unnecessary down time in spraying seasons by carrying out the proper maintenance.

3. Also check inlet and outlet valves and replace if worn. Worn valves not only reduce the output of the pump, but may reduce the life of the diaphragms.

#### Excessive Diaphragm Failure

If you have excessive diaphragm failure check the following points. These will cause failure of diaphragms due to added stress or chemical attack.

1. Most Important - Pump not being flushed out daily with clean water after use.
2. Oil level too low allowing air between piston and diaphragm.
3. Air leaks in suction line.
4. Restricted suction line.
5. Restriction through suction filter.
6. Not cleaning suction filter regularly.
7. Worn suction and discharge valves.
8. Bypass line too small to carry full capacity of pump.
9. In cold climates - frozen suction/discharge lines or water remaining in the pump after flushing.

# SECTION 7

## LUBRICATION & MAINTENANCE

10. Incorrect air setting or no air in air chamber.
11. Agitator excessively restricting bypass from pump.
12. Diaphragm material construction incorrect for chemical or solution being pumped.
13. Chemicals containing toluene or other aggressive solvents may require viton diaphragms - particularly if the pump is not properly flushed after use.

### Pre-Season Servicing

For thorough pre-season servicing - check all aspects of the sprayer and its operating components as outlined in the pre-delivery check list on page 1.7.

### Pump Storage and Corrosion Protection

#### 1. Warm Climates

If you operate in a warm climate with no chance of frost in the winter, you will not have any problems with frost damage.

If you are storing your sprayer between seasons, ensure your pump has been thoroughly flushed with clean water. A good idea is to run a mixture of 1% solution of summer mineral spraying oil through the pump and plumbing system. Summer spraying oil is water-soluble oil such as DC-Tron. This will coat and protect all internal pump parts. Ensure this mixture is flushed out before spraying commences in the new season.

#### 2. Cold Climates

For prolonged storage, an anti-freeze mixture can be flushed through the pump. Ensure this is thoroughly flushed out prior to the commencement of spraying again.

If the pump is being stored overnight and a risk of freezing is imminent, drain all liquid from the pump and lines, including boom lines.

### Hypro Centrifugal Pump Maintenance

#### Flush Centrifugal Pump After Use

Always flush the pump as instructed.

#### To Prevent Corrosion

After cleaning the pump as directed above, flush it with a permanent type automobile antifreeze (Pestone, Zerex, etc) containing a rust inhibitor.

Use a 50% solution - that is half antifreeze and half water, or fill the pump with fluid film and then drain it. A protective coat of fluid film will remain on the inner pump surfaces. Save excess fluid film for the next application.

Plug the ports of the pump to keep air out during storage. For short periods of idleness, noncorrosive liquids may be left in the pump but **air must be kept out.**



Remove & clean non-drip diaphragms regularly

### DIAPHRAGMS, STRAPS & FOAM MARKERS

#### Non-Drip Diaphragms (if fitted)

Non-drip diaphragms should be cleaned regularly to prevent dripping from nozzles.

To clean the non-drip diaphragms:

1. Completely stop all sprayer functions.
2. Unscrew and remove the diaphragm cap.
3. Remove and clean any sediment Off the diaphragm membrane.  
Replace the diaphragm membrane if damaged.
4. Refit the diaphragm.
5. Refit the diaphragm cap and carefully tighten.

## NOTE

**Do not over tighten the diaphragm cap. Over tightening the cap may impede flow through the diaphragm.**

# SECTION 7

## LUBRICATION & MAINTENANCE



Regularly check that tank straps are tight

### Tank Straps

Any tank straps of the flush tank should be kept tight so that the tank does not slide.

Tank clamps should be checked two or three times a day when the sprayer is new and the tank and frame are bedding-in.

Thereafter the tank clamps should be checked regularly.

### Foam Marker Maintenance

#### Arag Double Sided Foam Markers (Option)

##### Pressure relief valve

The pressure relief valve on the tank cap needs no maintenance.

Operating the pressure discharge ring under the tank cap prevents incrustations forming on the pressure relief valve at the same time checks its efficiency.

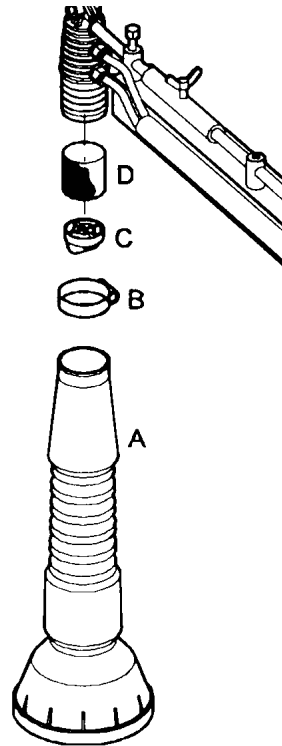

Weekly Cleaning (Figure 11)

##### Machine Down for Up to 7 Days

For periods of inactivity of at most 7 days, carry out the following operations:

- Slacken the band "B" and remove the diffuser "A".
- Remove the grid "C" turning it anticlockwise.
- Take the sponge "D" out of the foam nozzle.

- Carefully wash the foam diffusers and sponge with water.
- Reassemble the parts, taking care when inserting the sponge that must go freely into its seat without crushing that would alter the operation of the foam marker.
- Repeat the above operations for the other foam nozzle as well.

# SECTION 7

## LUBRICATION & MAINTENANCE

It's now much easier to identify the correct hydraulic hoses.

We would expect that operators may also colour code their tractors to make it even easier to consistently hook up the correct hoses to the same fittings time and time again. Less chance of expensive accidents.

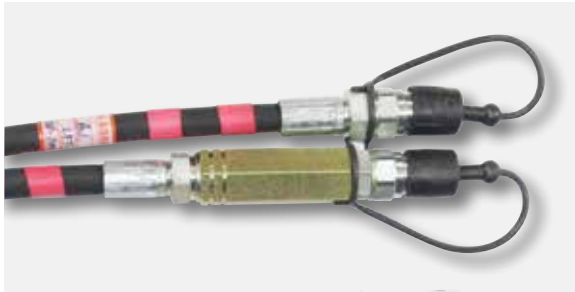

- (A) **Pressure** hoses to have **two colour bands**.
- (B) **Return** lines to have **one colour band**.

|               |                           |
|---------------|---------------------------|
| <b>Blue</b>   | = <b>FILL PUMP</b>        |
| <b>Red</b>    | = <b>FOLD or ELEC/HYD</b> |
| <b>Yellow</b> | = <b>Product Pump</b>     |
| <b>White</b>  | = <b>Lift</b>             |

### INSPECTION INTERVALS

#### MINIMUM RECOMMENDED TENSION INTERVALS FOR AG WHEELS

##### Initial fitment

- 4 hours of operation
- 9 hours of operation
- 16 hours of operation
- 24 hours of operation
- 48 hours of operation

### RETENTION AT



Alternatively, after the first 50km & subsequently every 100km, the stud bolt nuts are to be tightened by means of a dynamometric key and with the torque values listed below. Male and female treads are to be dry, however small amounts of anti-corrosive oil covering is permitted. Ongoing inspection & re-tensioning should be done in accordance with daily wheel/tyre inspection procedures. These inspection periods may vary depending on vehicle operating conditions.

#### RECOMMENDED TORQUE VALUES FOR TITAN AUSTRALIA AXLES

| Metric Wheel studs |                      |
|--------------------|----------------------|
| Stud Size          | Torque               |
| M12                | 73 ft.lbs (100 N.m)  |
| M14                | 122 ft.lbs (166 N.m) |
| M16                | 173 ft.lbs (235 N.m) |
| M18 (Pinto)        | 253 ft.lbs (344 N.m) |
| M20                | 372 ft.lbs (504 N.m) |
| M22 Csk Nut        | 442 ft.lbs (600 N.m) |
| M22 Cap/w Nut      | 425 ft.lbs (575 N.m) |
| M24 Csk/Nut        | 562 ft.lbs (762 N.m) |
| M24 Cap/w Nut      | 540 ft.lbs (732 N.m) |

| Imperial Wheel studs |                      |
|----------------------|----------------------|
| Stud Size            | Torque               |
| 7/16"                | 61 ft.lbs (83 N.m)   |
| 1/2"                 | 86 ft.lbs (117 N.m)  |
| 9/16"                | 134 ft.lbs (182 N.m) |
| 5/8"                 | 176 ft.lbs (239 N.m) |
| 3/4"                 | 297 ft.lbs (404 N.m) |
| 7/8"                 | 482 ft.lbs (654 N.m) |

These recommendations are supplied by Titan Australia – our major supplier for axles, wheels & tyres.

# SECTION 8

## TROUBLESHOOTING

### NOTE

This GENERAL manual is a generic overview to a variety of spray operations. It contains information relating to Broadacre and/or Horticulture operations. Some features and options explained in this manual may not be installed on your sprayer.

|                                      |           |
|--------------------------------------|-----------|
| <b>DIAPHRAGM PUMP PROBLEMS</b>       | <b>54</b> |
| <b>GENERAL SPRAYER PROBLEMS</b>      | <b>56</b> |
| <b>HYDRAULIC PUMP DRIVE PROBLEMS</b> | <b>57</b> |
| <b>FOAM MARKER PROBLEMS</b>          | <b>58</b> |

# SECTION 8

## TROUBLESHOOTING

### DIAPHRAGM PUMP PROBLEMS

| PROBLEM  | PROBABLE CAUSE   | REMEDY   |
|--|--|--|
| <b>A. Pump does not draw or deliver liquid. Pressure gauge fluctuates badly</b>                | <ol style="list-style-type: none"> <li>1. One or more valves are not seating properly.</li> <li>2. The pump is sucking in air through suction line.</li> <li>3. Air has not been entirely evacuated from the pump.</li> <li>4. Blocked suction filter.</li> <li>5. Damaged or worn suction valves.</li> </ol>  | <ol style="list-style-type: none"> <li>1. Clean valve seating.</li> <li>2. Examine the suction hose and ensure it is firmly secured.</li> <li>3. Rotate the pump with outlet hose and taps open.</li> <li>4. Clean suction filter.</li> <li>5. Replace suction valves.</li> </ol>  |
| <b>B. Liquid flow is irregular (Also check items under A)</b>                                  | <ol style="list-style-type: none"> <li>1. The air in the air chamber of the pump is incorrectly set.</li> <li>2. Diaphragm split.</li> <li>3. Damaged or worn valves.</li> <li>4. Foreign matter holding valves open.</li> </ol>   | <ol style="list-style-type: none"> <li>1. Check pressure in air chamber of pump. Set at 210-280Kpa (30-40 psi), or 10% of you average spraying pressure.</li> <li>2. Replace diaphragm.</li> <li>3. Replace valves.</li> <li>4. Clean valves.</li> </ol>   |
| <b>C. Pump delivers insufficient pressure</b>  | <ol style="list-style-type: none"> <li>1. Regulating valve: <ul style="list-style-type: none"> <li>• Sticking open</li> <li>• Not set for pressure</li> <li>• Damaged or worn seat or spring.</li> </ul> </li> <li>2. Cylinder diaphragm ruptured.</li> <li>3. Pump valves blocked, worn or damaged.</li> <li>4. Spray nozzles worn, missing or exceed pump capacity.</li> </ol> | <ol style="list-style-type: none"> <li>1. Fix the regulator: <ul style="list-style-type: none"> <li>• Unstick the valves</li> <li>• Set the pressure</li> <li>• Replace the spring.</li> </ul> </li> <li>2. Replace diaphragms.</li> <li>3. Unblock valves and or replace.</li> <li>4. Replace spray nozzles with appropriate size.</li> </ol> |
| <b>D. Output drops &amp; pump is noisy</b>   | <ol style="list-style-type: none"> <li>1. Oil level is too low.</li> </ol>   | <ol style="list-style-type: none"> <li>1. Top up with oil to correct level (1/2 way up the sump sight glass).</li> </ol>   |
| <b>E. Oil being discharged through delivery line or discoloured oil in sight glass of pump</b> | <ol style="list-style-type: none"> <li>1. One or more diaphragms split or ruptured.</li> </ol>   | <ol style="list-style-type: none"> <li>1. Immediately drain oil from pump and flush to remove all spray residues from sump. Remove pump heads &amp; fit new diaphragms. Fill to correct level with motor oil 20W/30.</li> </ol>  |

# SECTION 8

## TROUBLESHOOTING

### DIAPHRAGM PUMP PROBLEMS

| PROBLEM  | PROBABLE CAUSE   | REMEDY   |
|--|--|--|
| <b>SUCTION SIDE OF PUMP</b>  |  |  |
| <b>F. Suction hose vibration</b>   | 1. Air getting into suction.   | 1. Seal all joints securely with tape or sealant. Firm up clamps.  |
| <b>G. Pump valves hammering</b>  | 1. Suction tap partly turned off.<br>2. Suction strainer(s) blocked.   | 1. Turn tap fully on.<br>2. Clean filters.   |
| <b>H. No water flow on suction hose</b>  | 1. Obstruction in tank or suction line.  | 1. Clean foreign material from tank & suction line.  |
| <b>DISCHARGE SIDE OF PUMP</b>  |  |  |
| <b>I. Pressure gauge pointer swings violently</b>                                | 1. Pressure control valve spindle doesn't move easily.   | 1. Lubricate with light oil or C.R.C.  |
| <b>J. Control valve leaking from spindle</b>                                     | 1. Split diaphragm or O-rings.   | 1. Remove 4 body set screws, replace diaphragm and O-rings.  |
| <b>K. Pressure gauge showing correct working pressure no pressure at nozzle.</b> | 1. Burst discharge line.<br>2. Blocked pressure filter where fitted.<br>3. O-ring(s) jamming flow in discharge line.<br>4. Ants, wasps build nests in discharge line or nozzles. | 1. Replace discharge line.<br>2. Clean pressure filter.<br>3. Clean discharge line of foreign materials.<br>4. Clean nozzles of foreign materials with tooth brush |

# SECTION 8

## TROUBLESHOOTING

### GENERAL SPRAYER PROBLEMS

| PROBLEM   | PROBABLE CAUSE   | REMEDY  |
|---|--|---|
| <b>1. No spray when turned on</b>               | <ol style="list-style-type: none"> <li>1. Filter on the inlet side of the pump blocked.</li> <li>2. Faulty pump.</li> </ol>  | <ol style="list-style-type: none"> <li>1. Dismantle, clean &amp; re-assemble.</li> <li>2. Change pump.</li> </ol>   |
| <b>2. Sprays for short time only</b>            | <ol style="list-style-type: none"> <li>1. Air inlet to tank blocked.</li> <li>2. Filter on suction side of pump blocking or blocked.</li> </ol>                              | <ol style="list-style-type: none"> <li>1. Clean air vent.</li> <li>2. Dismantle, clean &amp; re-assemble the filter.<br/>If filter problem persists, clean out the tank &amp; start again.</li> </ol>   |
| <b>3. Spray is uneven around the spray-head</b> | <ol style="list-style-type: none"> <li>1. Some nozzle filters or tips are blocked.</li> <li>2. Nozzle tips worn.</li> <li>3. Different pressure along the boom.</li> </ol>   | <ol style="list-style-type: none"> <li>1. Remove, clean &amp; check. Check output &amp; for streaks.</li> <li>2. Check nozzle output, replace worn nozzles.</li> <li>3. Remove a nozzle in each section &amp; check that flow rate is the same.<br/>If different, check for blockages.</li> </ol> |
| <b>4. Pressure going up - output going down</b> | <ol style="list-style-type: none"> <li>1. Nozzle filters blocking.</li> </ol>  | <ol style="list-style-type: none"> <li>1. Dismantle, clean &amp; refit. Check pressure returns to normal.<br/>Check all filters and spray mixture.</li> </ol>   |
| <b>5. Pressure falling</b>                      | <ol style="list-style-type: none"> <li>1. Filter on suction side blocked.</li> <li>2. Nozzle tips worn.</li> <li>3. Pressure gauge faulty.</li> <li>4. Pump worn.</li> </ol> | <ol style="list-style-type: none"> <li>1. Dismantle &amp; clean the filter.</li> <li>2. Check nozzle output, replace worn nozzles.</li> <li>3. Check with new pressure gauge.</li> <li>4. Repair or replace the pump.</li> </ol>  |
| <b>6. Spray pattern narrow</b>                  | <ol style="list-style-type: none"> <li>1. Pressure too low.</li> <li>2. Pressure too low &amp; spluttering.</li> </ol>   | <ol style="list-style-type: none"> <li>1. Check that the correct nozzles are being used.</li> <li>2. Check that the tank is not empty. If not, there is an air leak between the pump &amp; tank or in the pump. Check plumbing &amp; repair.</li> </ol>   |
| <b>7. Foam in the tank</b>                      | <ol style="list-style-type: none"> <li>1. Too much agitation.</li> </ol>   | <ol style="list-style-type: none"> <li>1. Check that the return line is at the bottom of the tank.<br/>Partly close agitation and valve.</li> </ol>   |
| <b>8. Spray pattern streaky</b>                 | <ol style="list-style-type: none"> <li>1. Nozzle partly blocked.</li> </ol>  | <ol style="list-style-type: none"> <li>1. Remove &amp; clean. If it continues, the nozzle is damaged.<br/>Replace with same size tip, check flow rate of replacement nozzle.</li> </ol>   |



# SECTION 8

## TROUBLESHOOTING

### HYDRAULIC PUMP DRIVE PROBLEMS

| PROBLEM                                | PROBABLE CAUSE  | REMEDY   |
|--|---|--|
| <b>A. A Low discharge</b>              | <ol style="list-style-type: none"> <li>1. Pump not primed.</li> <li>2. Air leaks in suction line.</li> <li>3. Blocked or clogged line filter.</li> <li>4. Impeller plugged.</li> <li>5. Undersized or collapsed suction hose.</li> <li>6. Improperly sized hydraulic motor.</li> <li>7. Bypass adjustment screw not properly set.</li> <li>8. Eye of impeller rubbing on volute.</li> </ol> | <ol style="list-style-type: none"> <li>1. Remove top most vent plug from face of pump and run pump to expel trapped air.</li> <li>2. Check and reseal inlet fittings.</li> <li>3. Inspect filter &amp; clear any debris from screen.</li> <li>4. Inspect and clear obstruction.</li> <li>5. Suction line should be the same diameter as inlet port of pump or larger.</li> <li>6. Refer to pump selection guide to determine proper size.</li> <li>7. Adjust bypass screw on the side of the hydraulic motor.</li> <li>8. Remove volute (front cover) and inspect the impeller. If wear is detected, sand the impeller eye O.D. with emery cloth.</li> </ol> |
| <b>B. Hydraulic system overheating</b> | <ol style="list-style-type: none"> <li>1. Improper hydraulic motor size.</li> <li>2. Bypass adjustment screw set to bypass too much oil.</li> <li>3. Improper metering orifice installed in pressure port.</li> <li>4. Insufficient hydraulic hose size.</li> </ol>   | <ol style="list-style-type: none"> <li>1. Refer to pump selection guide to determine proper size for your system.</li> <li>2. Close adjustment screw on side of hydraulic motor to lessen the amount of bypassing oil.</li> <li>3. Install proper size orifice. Refer to Hypro Manual.</li> <li>4. Check hydraulic hose size. Hose should be at least ½". For large open-centre systems ¾".</li> </ol>   |

# SECTION 8

## TROUBLESHOOTING

### FOAM MARKER PROBLEMS - ARAG MARKER

| PROBLEM  | PROBABLE CAUSE  | REMEDY  |
|--|---|---|
| <b>The electric compressor will not work, the pilot lights fail to come on</b> | 1. No current reaches the control unit.   | 1. Check the fuse.<br>2. Check the electrical connections of the control box.   |
| <b>The electric compressor will not work, the pilot lights come on</b>         | 1. Electrical connection between control unit and electric compressor broken.   | 1. Check the connections between the control box and the electric compressor.   |
| <b>No foam comes out of dark the foam nozzles</b>                              | 1. The tank will not pressurize.<br>2. Break in the pneumo/hydraulic circuit.   | 1a. Close the tank cap properly.<br>1b. Check the tightness of the pipes connecting the compressor with the cap.<br>2a. Check there are no cracks in the dark the blue pipe inside the tank (from the filter to the plug) and on the outer pipes.<br>2b. Clean the bottom filter of liquid.<br>2c. Check for any constrictions along the pipes. |
| <b>Foam formation is not good</b>  | 1. Sponge dirty or hardened.<br>2. Water-foaming agent mix old.<br>3. Flow-rate adjustment wrong.<br>4. Constrictions in pipes. | 1. Clean or replace the sponge inside the foam nozzle.<br>2. Redo the water-foaming agent mix.<br>3. Use the flow-rate regulator on the tank cap to obtain a sufficiently dense foam.<br>4. Check the pipes towards the foam.   |
| <b>Foam continues to be formed in the foam nozzle not selected</b>             | 1. Solenoid valve jammed.   | 1. Disconnect the pipes going from the compressor unit to the foam node, then blow with compressed air into the unions of the solenoid valves towards.  |
| <b>Air bleeds from the safety valve on the cap</b>                             | 1. Constrictions in the pipes.<br>2. Solenoid valve jammed.   | 1. Check the pipes towards the foam nozzles.<br>2. Clean the relevant solenoid valve of liquid by blowing compressed air through the union leading to the foam nozzle.  |
| <b>Air or liquid leaks from the fittings</b>                                   | 1. Incorrect fitting seal.  | 1. At the quick connections or threaded fittings, uncouple the pipe and shorten it by approximately 10 rpm to eliminate the defects of deformation at the seal.   |

**For problems not specified, call your Dealer.**

# SECTION 9

## ASSEMBLY DRAWINGS, PARTS & SCHEMATICS

**ALL PARTS INFORMATION is now listed on the Croplands website:**

- Go to [croplands.com.au](http://croplands.com.au)
- Search in the Parts Information section linked to the home page.

### NOTE

Contact Croplands Technical Support  
for further information:  
**1300 650 724**

## **CROPLANDS**

### **AUSTRALIA**

Croplands Equipment Pty Ltd  
ACN 006 450 184

PO Box 2441  
Dry Creek  
50 Cavan Road  
Dry Creek SA 5094  
Australia

Freecall: 1800 999 162  
Freefax: 1800 623 778  
Email: [sales@croplands.com.au](mailto:sales@croplands.com.au)  
Website: [www.croplands.com.au](http://www.croplands.com.au)

### **NEW ZEALAND**

Croplands Equipment Ltd  
PO Box 2004,  
Stortford Bridge, Hastings 4120

Location:  
1422 Omaha Road,  
Hastings 4120  
New Zealand

Freecall: 0800 106 898  
Freefax: 0800 117 711  
Email: [sales@croplands.co.nz](mailto:sales@croplands.co.nz)  
Website: [www.croplands.co.nz](http://www.croplands.co.nz)

Your nearest Croplands Dealer  
can be found in the dealer section  
on the Croplands website