

CROPLANDS PART NUMBERS: A46263A0 – WOLF FLOWMETER 463 FLANGE 5-100LPM 40BAR

WOLF paddle flow-meter



Benefits

- Hi-precision and good price/performance ratio
- Variants with fork connectors for flexible connection layout
- Variants suitable for fitting into control units and equipped with hi-pressure brass flanges
- Operating status LED
- Sapphire paddle pin to minimize rotational friction and maximize sensitivity and accuracy
- Paddle assembly equipped with 'TWIST' system for either cleaning or replacing operations without the need of any tools
- Fully sealed and watertight electronic sensor
- Rates from 2.5 to 800 l/min

Features

- Typical error 1% of full scale
- Operating pressure: up to 40 bars*
- Power supply 4.5 to 26 Vdc
- 0-12 Vdc pulse output with frequency proportional to rate
- Max. consumption: 25 mA
- Parts in contact with the fluid are made of fiberglass and Delrin® reinforced Nylon



COD. CODE CÓD.			Attacco Connection Toma		
	l/min.	US GPM		P max (bar)	P max (PSI)
462 63A0	5-100	1.3-26	463	40	580

*: operating pressure depends on selected connector/union.

46262A0
 46262A03
 4626305
 4626315
 46263A0
 46263A03
 46263A04
 4626405
 4626406
 4626415
 46264A0
 46264A03
 46264A04
 4626506
 4626707

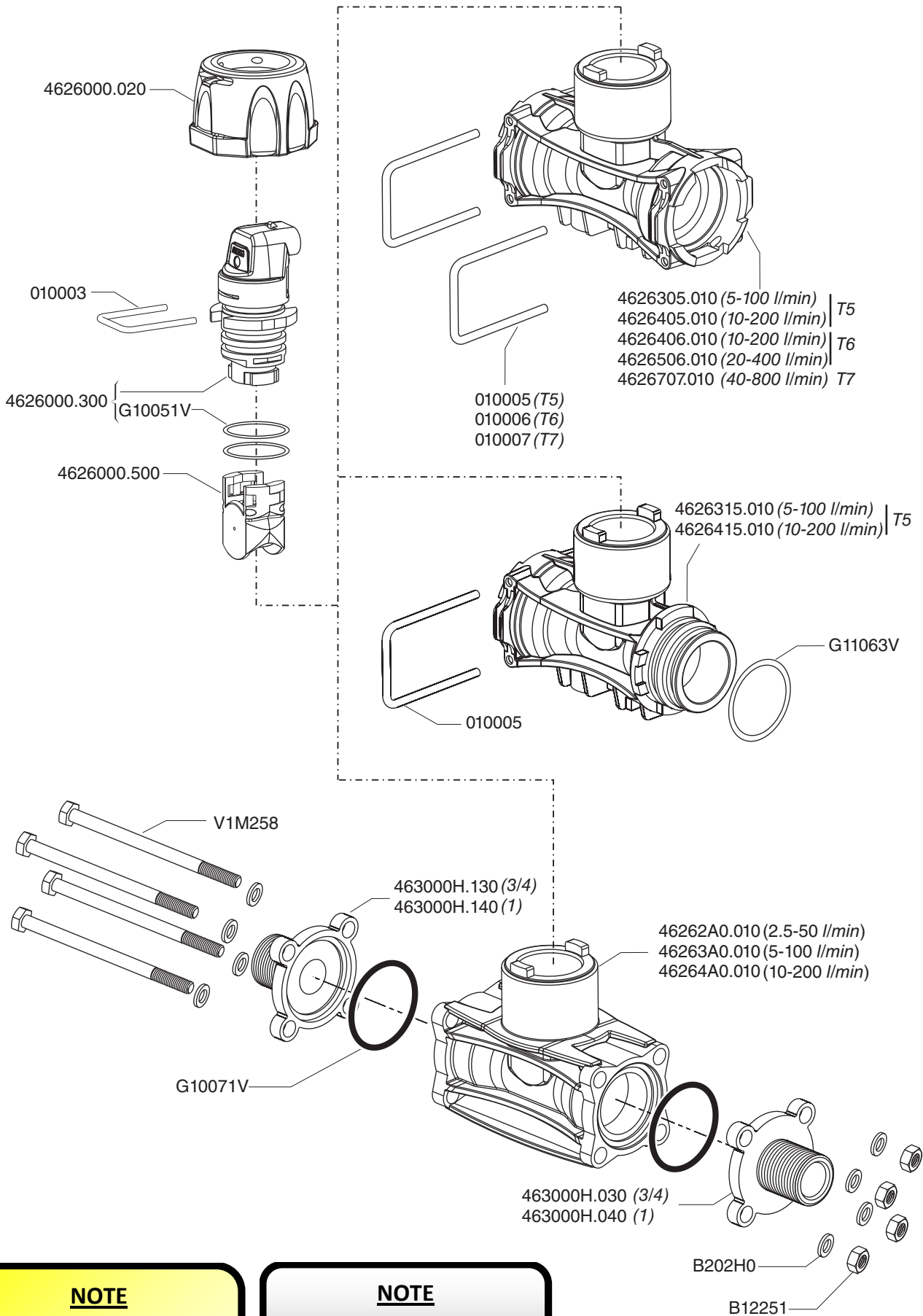

NOTE

PLEASE ADD PREFIX **A** TO
 PART NUMBER TO REFLECT
 CROPLANDS PART NUMBER

NOTE

SOME PARTS ARE NON-STOCK
 ITEMS AND MAY NEED TO BE
 ORDERED