

# Control Manifold

## A473CCRO01

Control manifold for auto-rate controllers, for pumps up to 280 l/min, manual pressure relief valve, electric bypass (7 sec), dump valve, 80 mesh self flushing filter, rapid check Polmac flowmeter and mounting brackets.

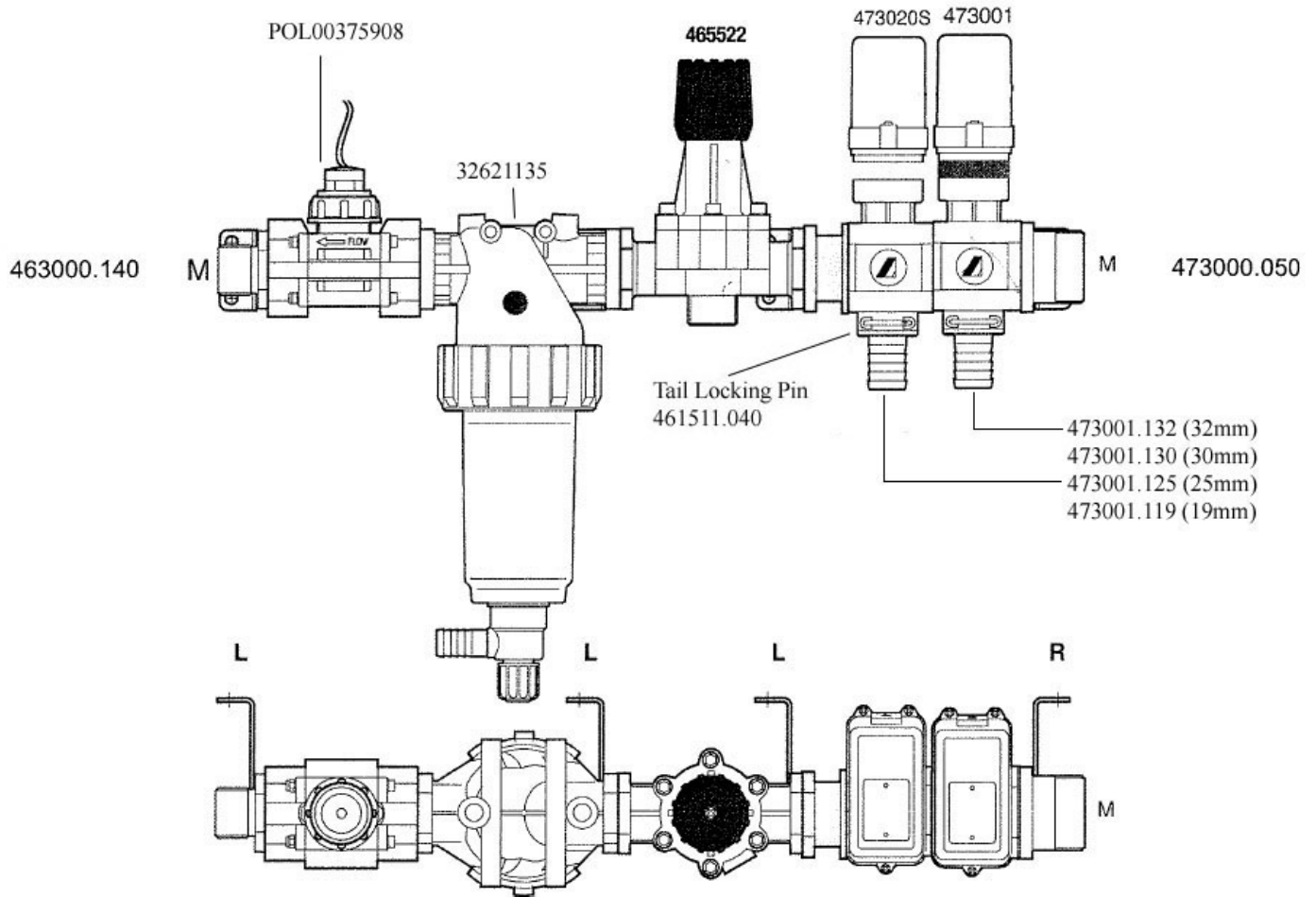

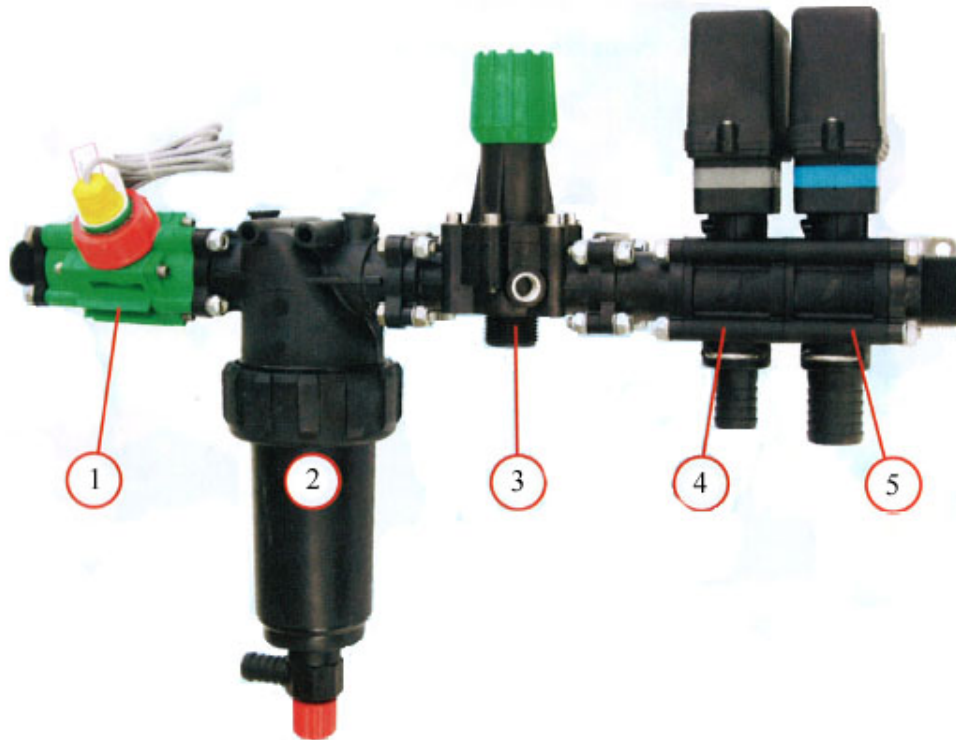



Location	Part Number	Description	Pressure	Max Flow L/Min.	By Pass
1	POL00375908	Polmac rapid-check flowmeter with sensor and flanges	20 bar	100 l/min	40 mm
2	A32621135	80 mesh flushing filter with manifold flanges	20 bar	150 l/min	40 mm
3	A465522	Manual Pressure Relief Valve	20 bar	200 l/min	32 mm
4	A473020S	Electric bypass valve, hi-flow, 7 sec open/close	20 bar	150 l/min	25 mm
5	A473001	Dump valve, high flow, 0.6 sec	20 bar	120 l/min	32 mm

Manual diaphragm pressure relief control valve with flanged coupling

- By-passes the excess liquid and maintains constant line pressure
- Equipped with a separation diaphragm for enhanced control sensitivity
- Fibreglass-reinforced Nylon body
- Internal parts in Delrin® and AISI 303 stainless steel
- Gaskets made of Viton®

COD.			
	BAR	PSI	BY-PASS (BSP)
465522	20	290	G1 M

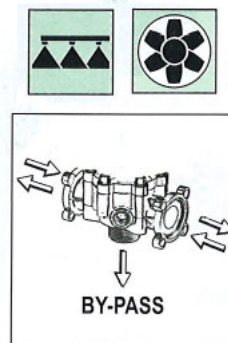



### Electric boom section valve

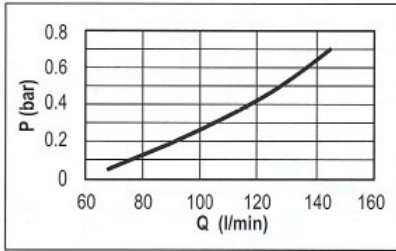

- Fibreglass-reinforced Nylon body
- Internal parts in Delrin® and AISI 303 stainless steel
- Gaskets made of Viton®
- **Flow rate 120 l/min (31 US GPM)**
- Internal resettable fuse (disconnecting power for 20 seconds)



COD.	Pressure		ON-OFF	Voltage	Fuse	Ø OUT		Ø OUT		TYPE																									
	BAR	PSI				mm	inches	mm	inches																										
473001	20	290	0.6 sec.	12Vdc	0.5A	12Vdc	19-25	3/4"	1"	<table border="1"> <thead> <tr> <th>Ø OUT</th> <th>mm</th> <th>inches</th> <th>l/min</th> <th>US GPM</th> </tr> </thead> <tbody> <tr><td>19</td><td>3/4"</td><td>80</td><td>21</td><td></td></tr> <tr><td>25</td><td>1"</td><td>120</td><td>31</td><td></td></tr> <tr><td>30</td><td>---</td><td>120</td><td>31</td><td></td></tr> <tr><td>32</td><td>1" 1/4</td><td>120</td><td>31</td><td></td></tr> </tbody> </table>	Ø OUT	mm	inches	l/min	US GPM	19	3/4"	80	21		25	1"	120	31		30	---	120	31		32	1" 1/4	120	31	
							Ø OUT	mm	inches		l/min	US GPM																							
							19	3/4"	80		21																								
							25	1"	120		31																								
30	---	120	31																																
32	1" 1/4	120	31																																
30-32	---	1" 1/4																																	

- Adjusts the flow in the control units in which treatments vary in proportion with engine rpm (DPM)
- Fibreglass-reinforced Nylon body
- Internal parts in AISI 303 stainless steel
- Gaskets made of Viton®
- **Flow rate 240 l/min (63 US GPM)**

### Electric proportional control valve

- Internal resettable fuse (disconnecting power for 20 seconds)

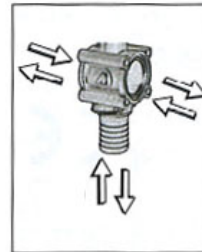

COD.	Pressure		ON-OFF	Voltage	Flow	Ø		
	BAR	PSI				mm	inches	
473020S	20	290	7 sec.	12Vdc	240	63	25	1"
							30	---
							32	1" 1/4



- Can be connected directly to the valves series 471, 463 and 464. Recommended to protect the control parts and to ensure maximum nozzle efficiency.
- Higher flow rate and pressure
- Cover with lock ring
- Self-cleaning version with drain valve

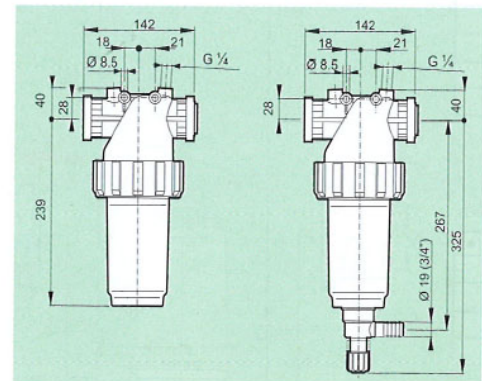

ricambio spare part

COD.	Type
3260035.030	Inox 80 mesh

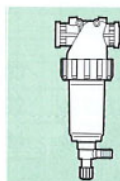

20 bar max  
290 psi max

210 l/min a 0.4 bar  
55 US GPM at 5 psi

SELF CLEANING COD.	SCREEN TYPE	EFFECTIVE AREA	
		cm <sup>2</sup>	sq.in.
32621135	Inox 80 mesh	97	15