

# CROPPACK 12 VOLT SPRAYERS

[www.croplands.com.au](http://www.croplands.com.au)

**CROPLANDS**



Attach product bar code here

**OPTIMA**  
CROPLANDS

Manual Part No. GP-OMCP12-C

# Welcome



*Sean Mulvaney, General Manager of Croplands*

Congratulations on the purchase of your new Croplands CropPak sprayer.

Croplands are in the business of building and selling spraying equipment and have been since 1972 (over 45 years). We supply sprayers to farmers, contractors, growers and others involved in growing crops & controlling pests and diseases.

Use our contact details here to contact our staff during business hours. After hours, e-mail us and expect a reply the following morning. We trust you will get years of good use from your Croplands CropPak Sprayer.

Yours sincerely,  
Sean Mulvaney  
General Manager

## **AUSTRALIA**

Croplands Equipment Pty Ltd  
ACN 006 450 184  
PO Box 2441, Dry Creek  
50 Cavan Road, Dry Creek  
S.A. 5094  
Australia

Freecall: 1800 999 162

Freefax: 1800 623 778

e-mail: [sales@croplands.com.au](mailto:sales@croplands.com.au)

website: [www.croplands.com.au](http://www.croplands.com.au)

## **NEW ZEALAND**

Croplands Equipment Ltd  
PO Box 2004,  
Stotford Lodge, Hastings 4120  
Location:  
1422 Omaha Road,  
Hastings 4120, New Zealand

Freecall: 0800 106 898

Freefax: 0800 117 711

e-mail: [sales@croplands.co.nz](mailto:sales@croplands.co.nz)

website: [www.croplands.co.nz](http://www.croplands.co.nz)

**Foreword**

**Product Identification & Specification**

**Assembly & Installation**

**Calibration**

**Operation**

**Maintenance & Trouble Shooting**

**Drawings & Spare Parts**

**Chapter 1**

**Chapter 2**

**Chapter 3**

**Chapter 4**

**Chapter 5**

**Chapter 6**

Pages

4

5-12

13-16

17-24

25-40

41-42

43-51



Read and understand this Operators' Manual before operating the CropPak sprayer.

**NOTE**

For conditions of warranty and warranty policy, please see the Warranty & Pre-Delivery booklet provided with this sprayer.

## About This Manual

This manual provides assembly, setting up, operating and maintenance instructions for the CropPak 12 Volt sprayers of the Croplands Optima range.

All types of the Optima range of 12 Volt sprayers are pictured on the front cover and in the Identification and/or in the Specification Chapter. Some model types also have different options available.

Some features explained in this manual may not be installed on your sprayer.

Please pass on this manual with the sprayer at the time of resale for usage by the new owner.

## Terminology

These terms/symbols used throughout this manual:

- **NOTE** - to convey useful operating information.
- **CAUTION** - to highlight potential injury or machinery damage.
- **WARNING** - to stress potential dangers and the importance of personal safety.
- **DANGER** - probability of death or serious injury if accident occurs.

## Before Operating Your Sprayer

- 1 Before attempting to use your sprayer, make sure you **read the Operator's Manual** and properly understand:
  - All Safety Issues.
  - Assembly & Installation instructions.
  - Calibration of the sprayer.
  - Sprayer Operation.
  - Sprayer Maintenance.
- 2 Read and follow instructions on chemical manufacturers' labels.
- 3 Always wear applicable protective clothing.

**NOTE**

To convey useful operating information.

 **CAUTION**

To highlight potential injury or machinery damage.

 **WARNING**

To stress potential dangers and the importance of personal safety.

 **DANGER**

Probability of death or serious injury if accident occurs.

<b>Product Identification</b>	<b>6</b>
<b>Model Specifications</b>	<b>7</b>
• <b>US30, 60 &amp; 100</b>	<b>7</b>
• <b>US200 &amp; US200B</b>	<b>9</b>
• <b>UM70</b>	<b>10</b>
• <b>UW50</b>	<b>11</b>



*Bar code.*



*Serial number plate.*



*Model & Serial number of a Flojet 3000 pump.*

## Product Identification

Where applicable, always use the Model and Serial Number of the Optima 12 Volt Sprayer when requesting service information or when ordering parts.

Early models or later models may use different parts, or it may be necessary to use a different procedure for specific service operations.

## Sprayer Part & Serial Number

Always use the serial number of the Optima 12 Volt Sprayer when requesting service information or when ordering parts.

Where a serial plate is not provided, please use the part number from the bar code affixed to this manual or the Warranty & Pre-Delivery booklet.

## Pump Model & Serial Number

The Pump Model & Serial Number is located on the pump. This plate shows name of manufacturer, type & model of pump, serial number, maximum voltage, maximum amperage, maximum flow rate and maximum working pressure of the pump.

For further information see the pump's manual or Croplands website – [www.croplands.com.au](http://www.croplands.com.au) and search in the Parts Information section on the landing page.

## NOTE

For further information on Croplands Sprayers, see [www.croplands.com.au](http://www.croplands.com.au).

## NOTE

Please supply the pump model number as a reference when ordering pump spare parts.



US30, 60 & 100.

## US30, 60 & 100 Litre Models

30/60/100 litre CropPaks – practical spot sprayers for a multitude of uses around the farm. Hook up to your 12 volt power source and get spraying.

For use in small trailers and/or utility vehicles, RTV vehicles, or 4-wheel motorbikes.

Ensure your vehicle is rated for the weight of the sprayer when full of liquid.



## WARNING

Ensure your vehicle is rated for the weight of the sprayer when full of liquid.

Failure to do this may cause instability & serious injury.



US30.

### Model

US30S

### Description

30 litre CropPak, with 12-volt on-demand 6.8 l/min open-flow ShurFlo pump, 6 metres of spray hose, spray lance and long power lead with on/off switch.

US60S

60 litre CropPak, with 12-volt on-demand 6.8 l/min open-flow ShurFlo pump, 6 metres of spray hose, spray lance and long power lead with on/off switch.



US60.

US100S

100 litre CropPak, with 12-volt on-demand 6.8 l/min open-flow ShurFlo pump, 6 metres of spray hose, spray lance and long power lead with on/off switch

US100S/15

100 litre CropPak, with 12-volt on-demand 15 l/min open-flow FloJet triplex pump, pressure regulator and gauge, 6 metres of spray hose, spray lance and long power lead with on/off switch.

Right:  
US60 on ATV.



## Model Specifications

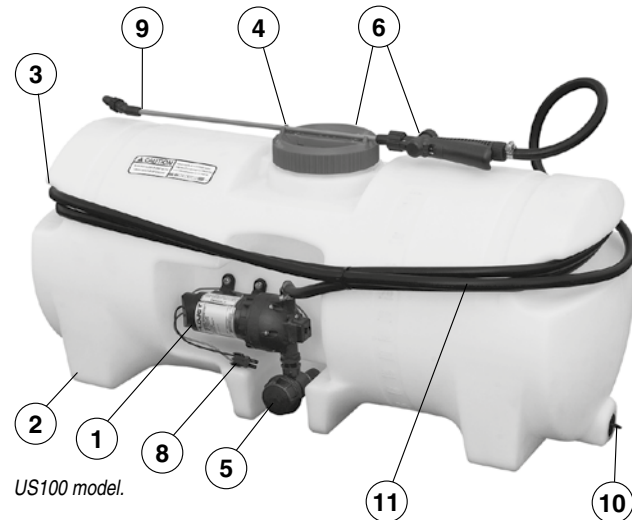

US100 model.

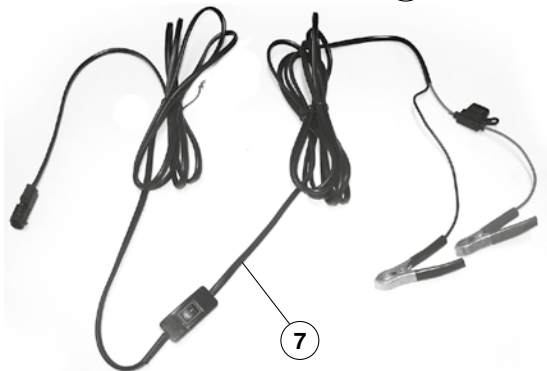

Long (7 metre), fused, heavy duty power lead with rocker-switch for easy hook-up to your battery.

## Product Identification & Specifications

	Feature	Benefit
1	Cavity mounted pump.	Total protection against the elements and damage. Low pump position ensures excellent priming.
2	Translucent tank.	Easy to see liquid level in the tank.
2	Rugged design, locally made.	Rotomolded tank has uniform thickness and can take high impact force.
2	UV stabilised tank.	Excellent UV resistance. Many imported models have no UV inhibitor in the material.
3	Large carry handles.	Easy handling and for storing hose neatly.
4	Lance clips onto lid.	Ensures neat storage and avoids lance dragging on the ground.
4	Large filling lid.	Helps prevent spillage when filling.
5	Large suction filter, easy access.	Very large filtering area with easy-clean filter screen. Simple and quick to access.
6	3-stage filtration.	Large filling screen under lid; large suction filter; pressure filter in lance handle.
7	Heavy-duty power cable.	Long, heavy-duty 12 volt power lead with rocker-switch for easy hook-up to your battery.
8	Quick-clip power connection.	High quality electrical connector to the pump with waterproof plug for quick hook up and reliability.
9	Metal lance with adjustable nozzle.	Superior to plastic, higher strength. Many accessories are available to fit the lance - see page 51.
10	Large drain.	Easy-to-use, large 'boat plug' drain for quick clean-out.
11	6 metre hose.	6 metres of high quality 20 bar rated spray hose fitted.





US200.

## US200 & US200B - 200 Litre 12 Volt Models

200 litre CropPaks – Larger model 12-volt sprayers for farms and vineyards. For use on a ute tray, UTV tray, tractor tray or trailer.

Ensure your vehicle is rated for the weight of the sprayer when full of liquid.



## WARNING

Ensure your vehicle is rated for the weight of the sprayer when full of liquid.

Failure to do this may cause instability & serious injury.



US200/15 featuring 3-way tap outlet for small booms.

### Model

US200

### Description

200 litre CropPak, with 12-volt on-demand 6.8 l/min open-flow ShurFlo pump, 6 metres of spray hose, spray lance and long power lead with on/off switch.

### US200/15

200 litre CropPak, with 12-volt on-demand 15 l/min open-flow FloJet triplex pump, pressure regulator and gauge, 3-way valve which enables connection to a boom, 6 metres of spray hose standard with spray lance. Long power lead with on/off switch provided.



US200B-20S.

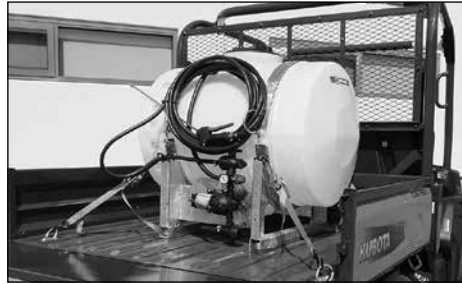

US200B-20S.

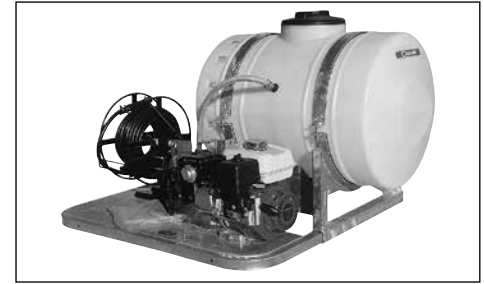

US200B/252 Honda motor driven model.

US200B/20S 200 litre CropPak with galvanised frame, 12-volt on-demand 20 l/min open-flow ShurFlo Quad pump, pressure regulator and gauge, 3-way valve which enables connection to a boom, 10 metres of spray hose standard with spray lance. Heavy duty power loom with on/off rocker switch for pump included. Ideal for spraying around the farm.

Booms can be fitted to the models using 15 & 20 l/min pumps, for use on utility vehicles and some RTV's. See Croplands Optima Buyers Guide for details of 2, 3, 4 and 6 metre booms and mounting kits for these models.

A separate boom manual will be supplied with your boom should you purchase a boom to suit your CropPak.

Other models utilising Honda motors are available. See the Croplands Optima Buyers Guide for further information.



### WARNING

**US200B models are designed for RTV/UTV side-by-side vehicles, utilities or trailers.**

**NOT SUITABLE for use on motorcycles.**

**NOT SUITABLE for use on hill country as rolling over may occur.**



UM70.



UM70/15 with 3 metre boom fitted.

### UM70 Litre Models

70 litre quad bike / ATV CropPak – 12-volt wrap around sprayers for quad bike use. Ensure your vehicle is rated for the weight of the sprayer when full of liquid.

#### Model

#### Description

UM70

70 litre CropPak, 12-volt on-demand 6.8 l/min ShurFlo pump, large filling lid, 6 metre hose and adjustable spray lance.

UM70/15

70 litre CropPak, 12-volt 15 l/min FloJet triplex pump with pressure adjustment regulator fitted, large filling lid, 6 metre hose and adjustable spray lance, pre-plumbed for boom.

A small boom can be fitted to the model using UM70/15 for use on some ATV's. See Croplands Optima Buyers Guide for details of 2, 3 and 4 metre booms for these models.

A separate boom manual will be supplied with your boom should you purchase a boom to suit your UM70/15 CropPak.



## WARNING

Ensure your vehicle is rated for the weight of the sprayer when full of liquid.

Failure to do this may cause instability & serious injury.



*UW50/2B.*

### **UW50 Litre Model**

50 litre "Greens" sprayer, 12-volt 6.8 l/min ShurFlo pump with pressure regulator and gauge. 3-way valve enables spraying via the 2 metre boom (with non-drip nozzles) or adjustable spray lance (with 10 metres of hose).

Three wheels provide excellent manoeuvrability for turf or bowling green spraying. Battery included.

<b>Assembly Instructions</b>	<b>14</b>
<b>Battery Connection</b>	<b>15</b>
<b>Fitting the CropPak to a Carrier</b>	<b>15</b>



*Unpack the sprayer.*

## Unpack the Sprayer

### CropPak Models - US30/60/100, US200, US200B, UM70, UW50

The US30/60/100/200/US200B models are supplied fully assembled except for:

- Assembly of the lance (disassembled for packing & transport).
- Connection to a 12 Volt battery.
- Fitting the unit to a vehicle (as required).

## NOTE

Whilst all precautions are taken in assembly and testing, it is possible that some tank fillings remain in the lines. These will accumulate in the suction filter when first used. Therefore, clean the filter out after initial use, and nozzles, if necessary.



*Check & clean the suction filter.*

## Assembly Instructions

To assemble the CropPak sprayer:

- 1 Unpack the unit and check that nothing is missing or has been damaged in transit.
- 2 Connect the lance to the hand grip and tighten the flange.
- 3 Check all worm-drive clips for tightness (if applicable).

*Remove and clean suction filter (UM70 only).*



*Refit the filter & suction line (UM70 only).*

- 4 Check and clean (if necessary) the suction filter:

- On UM70 models - Unscrew the filter, remove & clean. Refit the filter & suction line & tighten.
- All other models - Unscrew the suction filter cap, remove & clean the filter screen. Refit the screen & filter and re-tighten.

- 5 Check that the pressure line hose is connected.
- 6 Check the tank drain plug is fitted and sealed.

*Check the tank drain plug is sealed.*





Connect the power leads to a 12 Volt battery.

## Battery Connection

The pump must be connected directly to the +ive and -ive terminals of a 12 Volt battery.

To Connect the CropPak sprayer to a 12 Volt battery:

- 1 Unpack the wiring loom (UP-119B).

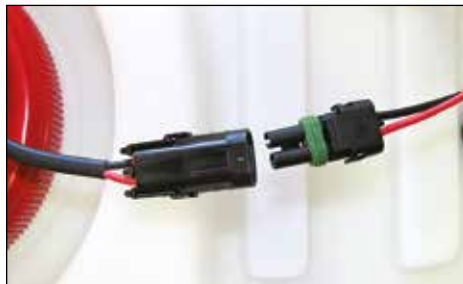

Connect the power lead to the pump.

- 2 Connect the power leads to a 12 Volt battery:

- The red (+ive) power lead to the positive (+ive) battery terminal, and
- The black (-ive) power lead to the negative (-ive) battery terminal.

The leads must be connected to a 12 Volt battery. Failure to connect leads to a battery of the correct voltage will cause damage to the electric motor.

- 3 Connect the power lead to the pump.

## Fitting the CropPak to a Carrier

The free-standing design of the CropPak units allows them to be used on many types of vehicles.

When using a CropPak on a vehicle, always strictly adhere to the vehicle manufacturer's load carrying specifications.

To fit the CropPak onto a vehicle:

- 1 Place the CropPak onto the vehicle.



## CAUTION

The leads must be connected to a 12 Volt battery.

Failure to connect leads to a battery of the correct voltage will cause damage to the electric motor.



## WARNING

When using a sprayer on a vehicle, always adhere to the vehicle manufacturer's load carrying specifications.

Failure to do this could result in serious damage and injury.



*UM70 includes a tie down strap.*

- 2 Secure the CropPak so that they are not able to slide around or tip over when the vehicle is moving. It is highly recommended to use good quality tie downs or ratchet straps. The UM70 comes supplied with a 4 metre strap.
- 3 Connect the CropPak power leads to the battery terminals (on vehicle) [see battery connection instructions on the previous page].

To remove the CropPak from a vehicle:

- 1 Disconnect the CropPak wires from the battery terminals.
- 2 If fastened, unfasten the CropPak from the vehicle.
- 3 Remove the CropPak from the vehicle and store in a suitable location, preferably undercover protected from the sun and the weather.

Ensure the sprayer is drained and flushed prior to storage.



## WARNING

If the CropPak is fitted to any:

- ATV,
  - Two or four wheel motorcycle,
- the CropPak **MUST BE** secured with suitable self-locking carry straps.

## NOTE

Whilst all precautions are taken in assembly and testing, it is possible that some tank filings remain in the lines. These will accumulate in the suction filter when first used. Therefore, clean the filter out after initial use, and nozzles, if necessary.



## CAUTION

The leads must be connected to a 12 Volt battery.

Failure to connect leads to a battery of the correct voltage will cause damage to the electric motor.



<b>Calibration</b>	<b>18</b>
• <b>Spot Sprayer</b>	<b>19</b>
• <b>Boom Sprayer</b>	<b>22</b>

### NOTE

The 12V CropPak range should be operated at pressures less than 3.0 Bar (43psi). Exceeding this pressure may damage the pump and/or overheat the wiring loom.

## Calibration

Today, we must strive for the most efficient use of spray chemicals for effective pest and disease control.

Increasing costs, as well as consumer and public pressures to minimise residues, requires us to achieve the target application rate (uniform spray coverage without over or under spraying).

Applying the correct amount of chemical to a crop is only possible if the:

- Sprayer is calibrated correctly (this chapter).
- Sprayer is operated correctly (see chapter 4).
- Sprayer is maintained correctly (see chapter 5).

Correct chemical application rate can only be achieved if the variables of spray application are measured and controlled:

- Distance, time & working width are measured.
- Liquid & chemical volume applied.

This is done through sprayer calibration.

Sprayer calibration is one of the single most important factors in establishing the correct application rate of the sprayer.

Without calibration it is not possible to know the actual rate of spray application.



### CAUTION

**Do not operate a sprayer without calibration or before calibration has been completed.**

**Failure to calibrate a sprayer before operating may result in ineffective or crop damaging spray application.**



*Spot spraying application.*

## Spot Sprayer Calibration

CropPak sprayers are most commonly used for spot spraying using a hand gun with a single variable cone or flat fan nozzle.

Precise application rates are not usually achieved with hand guns because the application rate is entirely dependent on the operator.

Two steps are recommended for calibrating a spot sprayer:

- 1 Choose the appropriate nozzle.
- 2 Check the nozzle operates correctly.

### Step 1

#### Choose the Appropriate Nozzle

The nozzle used should be appropriate for the chemical being used. The standard adjustable ConeJet should suffice for general Glyphosate-based formulations & applications. Follow the chemical manufacturer's recommendation for any specific nozzle requirements as per the manufacturers label.

The standard CropPak lance has a removable cap, the adjustable ConeJet can be removed and most 80 and 110 degree flat fan nozzles can then be used with the cap & seal.



*ShurFlo SHU8000-547-189 pump.*

### Pump Specification

The nozzle chosen must be within the flow capability of the pump on your CropPak. CropPak sprayers are fitted with pumps that operate within a pressure range.

**The pump model ShurFlo SHU8000-547-189** is a diaphragm pump with an internal bypass which allows the pump to work with a nozzle within a range of flow from approximately 1 litre per minute to 2.5 litres per minute in the correct pressure range for the pump.

This pump is used on the US30S, US60S, US100S, UM70 CroPak models and the UW50/2B Greens Sprayer.



*Flojet FL3521-139 pump.*



*ShurFlo SHU5059-3611-D011 pump.*

The pump model **FloJet FL3521-139** is a diaphragm pump with an internal bypass which allows the pump to work with a nozzle within a range of flow from approximately 1 litre per minute to 6 litres per minute in the correct pressure range for the pump.

This pump is used on the UM70/15, US200/15 and US100A/15 CropPak models.

The pump model **ShurFlo SHU5059-3611-D011** is a diaphragm pump with an internal bypass which allows the pump to work with a nozzle within a range of flow from approximately 1 litre per minute to 11 litres per minute in the correct pressure range for the pump.

This pump is used on the US200B/20.1S 12-volt CropPak.

The 8000 Series ShurFlo pump is fitted with an inbuilt automatic shut off pressure switch which will switch the pump:

- ON, when low pressure is detected, and
- OFF, when the preset high pressure is reached.

This is ideal for spot spraying applications.



## CAUTION

**Do not operate a sprayer without calibration or before calibration has been completed.**

**Failure to calibrate a sprayer before operating may result in ineffective or crop damaging spray application.**

## NOTE

**Check the current Croplands Optima Buyers Guide for Nozzle information.**

## NOTE

**The CropPak models US200/15 and US200B/20S have the 15 L/min Flojet pump & 20 L/min Shurflo pump fitted respectively. They will have a regulator fitted on the outlet as a "boom-ready" feature to allow pressure regulation.**



Fill the spray tank with the lid filter in place.



Hold down the hand grip lever to spray

## Step 2

### Check the Nozzle Operates Correctly

- 1 Fill the sprayer tank with clean water making sure the lid filter is in place.
- 2 Connect the sprayer power leads to a 12 volt battery (see battery connection instructions in chapter 2).
- 3 Switch On the pump.

- 4 Hold down the hand grip lever to spray and check that the:
  - Spray pattern is even.
  - Pump pressure is sufficient and that the pump is not cycling On and Off too often.
  - If using a variable cone nozzle, adjust the cone to make the spray pattern required.
- 5 Release the hand grip lever to stop spraying.

- 6 Switch Off the pump.
- 7 If necessary, make any adjustments and re-check.

When the nozzle operates correctly, the sprayer is ready for operation.

## NOTE

**Nozzle spray patterns and spray angles should be visually checked for accuracy and the nozzle replaced if not spraying correctly.**



*Boomspraying.*

## Boom Spraying

Some CropPak models also have booms supplied (for example UW50/2B) and most CropPak models with larger pumps can have, if required, a boom up to 4 metres fitted.

Each Croplands boom is fitted standard with non-drip nozzle bodies so that when the liquid flow is switched off, the bodies will not drip.

Also supplied on our booms are AirMix® air-induction ultra low-drift nozzles - now an industry standard to reduce the likelihood of spray drift.

The liquid flow to the boom can be stopped & started as required (such as when turning at headlands or where the operator does not want to spray) by using the switch integrated into the standard electrical loom that runs from the pump to the vehicle battery.

To ensure the right application of herbicide or crop protection product is applied to the target crop, the user should calibrate the boom to ensure the correct application rate is used for the chemical being used.

This information (spray target rate and spray quality) is usually supplied by the chemical manufacturer on their product label. Alternatively, a trained agronomist should be consulted.

Note the CropPak range will generally only be suitable for spraying up to 8-10 Km/hr - above this speed the 12-volt pumps may not supply enough flow to the nozzles.

Part of the calibration process is to determine the maximum flow required to meet the required target spray rate, and this information can be used to determine what speed of travel will best suit your application.

In the case of the UW50/2B, the speed will likely be a normal walking speed of approximately 4 km/h, which is well within the limits of the 12-volt pump fitted on the unit.

If you have purchased a boom to use with your CropPak with the 12-volt pump suitable for this application, you will be supplied with a boom manual that explains the calibration process in more detail.

A brief guide for calibration is set out below.

## Calibration

There are 3 things you require to know or check:

- 1 Speed of travel,
- 2 Nozzle spacing, and
- 3 Nozzle pressure, or nozzle output in l/min.

### 1 Speed of travel

Check your ute / tractor / ATV speed. If you have an accurate speedometer, this will suffice. If not, measure the distance you have travelled in one minute in metres, and divide this by 16.7,

$$\begin{aligned} \text{e.g. } & 120 \text{ metres travelled in one minute} \div 16.7 \\ & = 7.18 \text{ km/hour.} \end{aligned}$$

If this is impractical, measure the distance travelled in 30 seconds, double it, and then divide by 16.7.

Repeat at least twice, from a running start, to ensure accuracy.

### 2 Nozzle spacing

All Croplands booms suitable for CropPak sprayers have 50cm nozzle spacing.

NOZZLE	BAR	L/MIN	Km/hr									
			4	5	6	7	8	9	10	12	16	
110-02	1	0.46										
	1.5	0.56										
	2	0.65							78.0			
	2.5	0.72										
	3	0.79										

*This chart illustrates a 110° 02 nozzle (yellow) operating with 2 Bar spraying pressure giving an output of 0.65 l/min and travelling at 10 km/hr applying 78 litres per hectare of water using 50cm nozzles spacing.*

### 3 Pressure or flow

If your sprayer has an accurate pressure gauge, set it to the desired pressure for the type of nozzle you are using. If you are unsure of this, generally 2 bar (30 psi) is ideal for most nozzles.

If you do not have an accurate gauge, measure the nozzle output, in litres per minute with an accurate measuring jug & stopwatch.

Use the following chart to determine your litre per hectare (l/ha) application rate.

In the example above,:

- The nozzle is a 110° 02 nozzle (yellow),
- At 2 Bar spraying pressure, it has an output of 0.65 l/min, and
- At 10 km/hr you will apply 78 litres per hectare of water,
- With the nozzles at 50cm spacing.

Multiple nozzles do not affect the outcome - if you have eight nozzles on your boom your application is the same per hectare.

To find more information on how to calibrate a boom for varying application rates,:

- Refer to the Croplands web site at [www.croplands.com.au](http://www.croplands.com.au) or
- Contact the Croplands Customer Service or Technical Support: Phone 1300 650 724.



## **Initial Start-Up Procedure:**

- **For models without Regulator Kit** 26
- **For models with Regulator Kit** 28

**Adding Chemical to the Spray Tank** 31

**Tank Agitation** 32

**Operating the Hand Gun** 33

**Hand Gun Spraying Method** 34

**Boom Spraying** 35

**Daily Start Up Procedure** 36

**Operating Pointers** 37

**Useful Formula** 37

**Daily Clean & Flush the CropPak** 38

**Using Tank & Equipment Cleaners** 39

**Safety Instructions** 40



Fill the spray tank with the lid filter in place.



Hold down the hand grip lever to activate & prime the pump.

## Initial Start-Up Procedure

After assembly and installation procedures are complete, it is important to check that the pump will prime and operate properly.

To initially start operating the sprayer:

- 1 Check that the spray tank is clean.
- 2 Check that the suction line filter is clean.
- 3 Check all plumbing and fittings are tight and not damaged or leaking.
- 4 Fill the sprayer tank with clean water - making sure the basket filter is in place when filling.

### NOTE

**Do not add chemical to the tank until you have checked the unit is fully operational.**

- 5 Connect the sprayer power leads to a 12 volt battery (see battery connection instructions in chapter 2).
- 6 Switch On the pump.  
This will normally activate the pump to automatically prime itself and run until the preset shut-off pressure is reached.
- 7 Hold down the hand grip lever. This will normally activate the pump to fully prime and pump water through the spray line.

### If the pump fails to prime ...

On initial start-up, the 12 Volt pump may fail to automatically prime.

When the inside valves of the pump are dry, the pump will not automatically prime as the valves do not seal off the air.

This can occur when the:

- Pump is new,
- Pump has not been properly flushed with clean water after use, or
- Pump has not been used for a period of time.

This problem is easily fixed by wetting the valves.

To wet the pump valves:

- a) Disconnect the spray lance from the gun itself.
- b) Squeeze the gun trigger so liquid flows unrestricted from the gun body. This liquid can be directed into the tank opening. Flow may take a few seconds.

### NOTE

**It is important to check that the pump is fully primed and operates properly. If this is not done the sprayer will not function properly.**



*Hold down the hand grip lever to prime & operate the sprayer.*



*Adjust the variable cone nozzle for the required spray pattern.*

c) Reconnect the spray lance to the gun.

This procedure should successfully prime the pump.

8 Hold down the hand grip lever to operate the sprayer.

Each time the hand gun lever is held down, the pressure drop is sensed by the pump. The pump then automatically switches itself On & Off as required to maintain pressure.

Pressure build-up automatically shuts off the pump, and pressure drop automatically restarts the pump.

9 While the hand gun is spraying, check that the:

- Nozzle spray pattern is even,
- Pump pressure is sufficient and that the pump is not cycling On and Off too often,
- If using a variable cone nozzle, adjust the cone for the required spray pattern.

10 Release the hand grip lever to stop spraying.

11 Switch Off the power to the pump when the initial start-up procedure is completed.

12 If required, make the necessary adjustments and re-check the sprayer operation.

After the initial start-up procedure is successfully completed, the sprayer is ready for operation.



## CAUTION

**When the tank becomes empty, the pump will continue to run. Running the pump dry temporarily will not cause damage. However, avoid letting the pump run dry for long periods.**



Fill the spray tank with the lid filter in place.



Hold down the hand grip lever to activate & prime the pump.

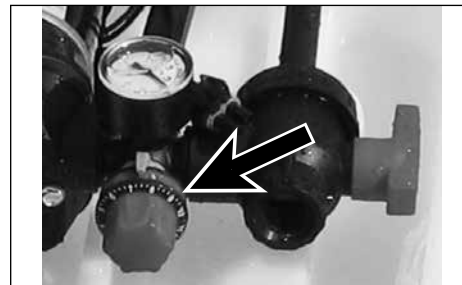

Manually adjust the Pressure Regulating Valve to set the desired pressure.

## Initial Start-Up Procedure

If you have purchased your CropPak with a larger (15 or 20 l/min) pump, it will have a pressure regulator to regulate pressure and flow, instead of a pressure switch on the pump.

After assembly and installation procedures are complete, it is important to check that the pump will prime and operate properly.

To initially start operating the sprayer:

- 1 Check that the spray tank is clean.
- 2 Check that the suction line filter is clean.

- 3 Check all plumbing and fittings are tight and not damaged or leaking.
- 4 Fill the sprayer tank with clean water - making sure the basket filter is in place when filling.
- 5 Connect the sprayer power leads to a 12 volt battery (see battery connection instructions in chapter 2).
- 6 Switch On the pump.

This will normally activate the pump to automatically prime itself.

- 7 Hold down the hand grip lever. Once the unit is spraying clean water, adjust the Pressure Regulating Valve (PRV) to the desired pressure, using the pressure gauge to determine the operating pressure.
- 8 When not spraying for any length of time, switch the pump off or disconnect the unit from the battery.

## NOTE

**Do not add chemical to the tank until you have checked the unit is fully operational.**

## NOTE

**As there is no pressure switch fitted, the 15 l/min Flojet pump will continuously run bypassing liquid to the tank while the spray gun is closed.**

## NOTE

**When not spraying for any length of time, switch the 15 l/min Flojet pump off or disconnect the unit from the battery.**

**If the pump fails to prime ...**

On initial start-up, the 12 Volt pump may fail to automatically prime.

When the inside valves of the pump are dry, the pump will not automatically prime as the valves do not seal off the air.

This can occur when the:

- Pump is new,
- Pump has not been properly flushed with clean water after use, or
- Pump has not been used for a period of time.

This problem is easily fixed by wetting the valves.

To wet the pump valves:

- Disconnect the spray lance from the gun itself.
- Squeeze the gun trigger so liquid flows unrestricted from the gun body. This liquid can be directed into the tank opening. Flow may take a few seconds.
- Reconnect the spray lance to the gun.

This procedure should successfully prime the pump.

**CAUTION**

The 15 L/min Shurflo pump models should not be operated at more than 3.0 Bar (43psi). Exceeding this pressure may damage the pump and/or overheat the wiring loom.

**CAUTION**

The 15 L/min Flojet pump models should not be operated at more than 3.0 Bar (43psi). Exceeding this pressure may damage the pump and/or overheat the wiring loom.

**NOTE**

It is important to check that the pump is fully primed and operates properly. If this is not done the sprayer will not function properly.



*Adjust the variable cone nozzle for the required spray pattern.*

- 9 While the hand gun is spraying, check that the:
- Nozzle spray pattern is even,
  - Pump pressure is constant and within the limit of the maximum pressure rating (3 Bar [43 psi]),
  - If using a variable cone nozzle, adjust the cone for the required spray pattern.
- 10 Release the hand grip lever to stop spraying.
- 11 If required, make the necessary adjustments and re-check the sprayer operation. Use the power switch to turn the power Off.

After the initial start-up procedure is successfully completed, the sprayer is ready for operation.



## CAUTION

**When the tank becomes empty, the pump will continue to run. Running the pump dry temporarily will not cause damage.**

**However, avoid letting the pump run dry for long periods of time because damage may occur from over heating.**

## Adding Chemical to the Spray Tank

Chemical should only be added to the spray tank after initial start up procedure is complete.

The steps for adding chemical to the tank are:

- 1 Calculate the amount of chemical required.
- 2 Part fill the spray tank with water.
- 3 Measure and pre-mix the chemical.
- 4 Add the pre-mixed chemical to the tank.



### CAUTION

**Do not add chemicals to the spray tank until the initial start-up or daily start-up procedure has been carried out.**

**This avoids having a tank full of toxic chemical and then finding a sprayer problem.**

### Step 1

#### Calculate the Amount of Chemical Required

To add the correct amount of chemical to a tank, it is necessary to calculate the amount of chemical required.

The method of calculating the amount of chemical required for the sprayer tank is dependent on the chemical rate recommendations. Use the information supplied on the chemical label to determine the tank-mix concentration.

If you are unsure of the mix required, ALWAYS check with a qualified advisor or the supplier of the chemical you intend to use.

### NOTE

**Be sure to mix only enough spray mixture to cover the area required.**

**Mixing too much chemical creates unnecessary waste and costs.**

## Step 2

### Part Fill the Spray Tank with Water

Part fill the sprayer tank with clean water.

Use fresh water (preferably rainwater), free of suspended organic matter or clay. Some chemicals are deactivated when they contact these materials.

Ensure water quantity is sufficient to allow correct product blending.

## Step 3

### Measure & Pre-Mix the Chemical

Read and follow the instructions on the chemical manufacturers label before mixing & adding chemicals to the spray tank.

Chemicals should be accurately measured and thoroughly premixed in a separate container before adding to the spray tank:

- 1 Measure out the required liquid chemical in a graduated measuring cylinder or bucket.

- 2 Add chemical to a small volume of water in a container and thoroughly mix the chemical.

### Tank Agitation

It is important to use chemicals that naturally remain in solution while in a CropPak spray tank.

After chemicals have been added to most CropPak sprayer, the tank can only be agitated by:

- Rocking the tank (with the lid firmly in place), or
- Placing the hand gun lance into the tank liquid and pressing the hand gun lever.

Only the sprayers fitted with the FL3521 & SHU5059 series pumps and regulator kits have a bypass to provide continuous tank agitation while the pump is operating.



## CAUTION

**Always follow chemical label instructions. When handling chemicals always wear protective clothing, ie. gloves, face mask, spray suit.**



## CAUTION

**Should chemical come in contact with skin immediately rinse off with water. Always follow chemical label safety instructions.**



**Step 4****Add the Chemical to the Tank**

Always make sure the filling basket is in place when adding water or chemical to the tank.

To add the premixed chemical to the tank:

- 1 Add the pre-mixed chemical to the tank, thoroughly rinsing the chemical pre-mix container and adding the rinse to the tank.
- 2 Top up the tank with water to the required volume.
- 3 Close the tank lid securely.

**NOTE**

**Do not to use chemicals which settle without adequate agitation in the tank of CropPak sprayers except for those fitted with SHU5059 & FL3521 series pumps and regulator kit.**

**Step 5****Operating the Hand Gun**

After chemical has been added to the tank, the sprayer is ready for operation.

To operate the hand gun:

- 1 Make sure the sprayer power leads are connected to a 12 volt battery (see battery connection instructions in chapter 2).
- 2 Switch On the pump.

This will normally activate the pump to run until the preset shut-off pressure is reached.



*Place the lance into the lid storage clips.*

- 3 Aim the nozzle at the target area and hold down the hand grip lever to spray the target.

Move the nozzle as required to completely spray the target.

Use the hand gun trigger to turn the spray On & Off as required.

- 4 When spraying is finished, place the lance into the storage clips provided on the tank lid.

Switch off the pump or disconnect the power leads from the battery.

**CAUTION**

**Always wear approved safety clothing and protective respiratory equipment when spraying.**

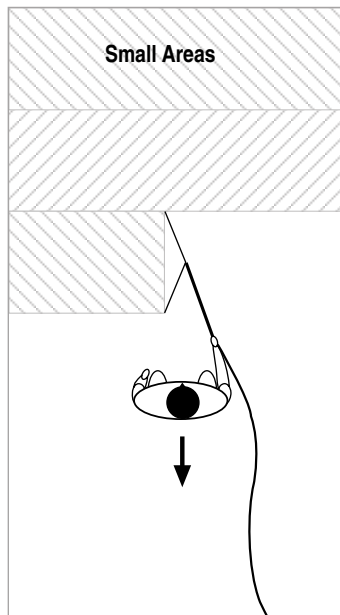

*In small areas, spray across the area & move back toward the wind.*

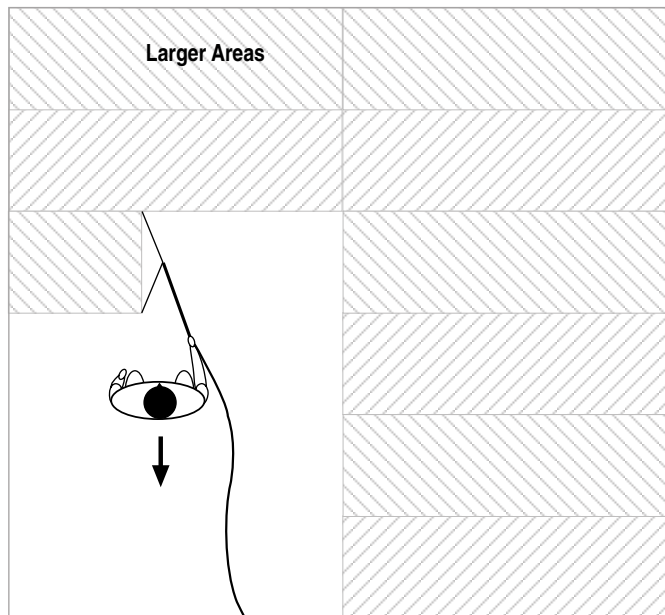

*In larger areas, divide the area into smaller segments & move back toward the wind keeping track of the area sprayed to avoid under or overspraying.*

## Hand Gun Spraying Method

It is always preferable to spray with your back toward the wind direction so that the wind carries spray away from the operator.

The operator should where possible, avoid walking on previously sprayed areas to avoid unnecessary fumes and contamination.

Operate with the sprayer situated behind the operator so that the hose from the sprayer can be kept on unsprayed areas.

This is important because the operator usually has to handle, extend and rewind the hose many times, as he shifts from area to area.

If the hose is kept relatively free from spray contamination there is less exposure to chemical contamination.

## NOTE

**It is recommended to keep the hose from the sprayer on unsprayed ground and uncontaminated from the spray.**

**This minimises contaminants on the hose minimises exposure to chemicals when handling and rewinding the hose.**

## Boom Spraying

Some CropPak models also have booms supplied (for example UW50/2B) and most CropPak models with larger pumps can have, if required, a boom up to 4 metres fitted.

A separate boom manual will be supplied with calibration information and installation instructions.

Each Croplands boom is fitted standard with non-drip nozzle bodies so that when the liquid flow is switched off, the bodies will not drip.

Also supplied on our booms are AirMix® air-induction ultra low-drift nozzles - now an industry standard to reduce the likelihood of spray drift.

The liquid flow to the boom can be stopped & started as required (such as when turning at headlands or where the operator does not want to spray) by using the switch integrated into the standard electrical loom that runs from the pump to the vehicle battery.

To ensure the right application of herbicide or crop protection product is applied to the target crop, the user should calibrate the boom to ensure the correct application rate is used for the chemical being used.

See Chapter 3 for Calibration instructions.

The spray target rate and spray quality information is usually supplied by the chemical manufacturer on their product label.

Alternatively, a trained agronomist should be consulted.



Fill the spray tank with the lid filter in place.



Hold down the hand grip lever to activate & prime the sprayer.

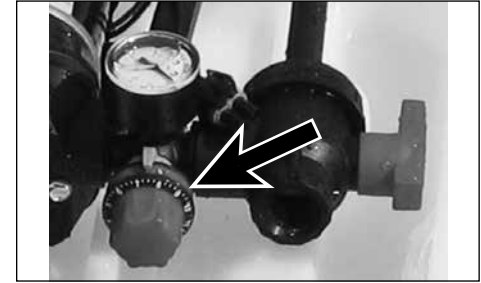

If fitted, adjust the pressure relief valve to obtain the required pressure not exceeding 3 Bar.

## Daily Start Up Procedure

A careful, common sense approach to water quality, mixing of chemicals and care of filters, hoses and tank will ensure trouble free spraying.

To ensure trouble free operation, follow the procedure below at the start of each day:

- 1 Ensure that no solids enter the system to block or damage pump or nozzles.

- 2 Check that suction line filter is clean and not damaged. It should be **checked & cleaned regularly**.

Be careful not to damage or deform the mesh or O-Ring while cleaning and refitting the suction line filter.

If a filter screen is damaged, replace with a new screen.

- 3 Put enough clean water into the spray tank to operate the pump and hand gun.
- 4 Activate the pump and ensure it primes correctly - hold the hand grip lever down, until the hand gun sprays steadily.

- 5 If fitted, adjust the pressure relief valve to obtain the required pressure.

Excess liquid will bypass back to the tank.

Once the pressure is set, it is normal for minor fluctuations to show on the pressure gauge when switching the hand gun On & Off.

- 6 Check that all hoses, hose clamps and connections do not leak.  
Repair or replace damaged components.
- 7 Read and follow the instructions on the chemical manufacturers label before mixing and adding chemicals to the spray tank.
- 8 Add chemical to the tank and proceed with your spray application.



## CAUTION

**Do not add chemicals to the spray tank until the initial start-up or daily start-up procedure has been carried out.**

**This avoids having a tank full of toxic chemical and then finding a sprayer problem.**

## Operating Pointers

While spraying continually observe that:

- 1 Adequate operating pressure is being maintained.
- 2 Your hand gun coverage is correct and constant for effective cover.
- 3 The nozzle is operating correctly.
- 4 Periodically check and clean filters.
- 5 Avoid going too slow because over application will occur.  
Conversely, avoid going too fast because under application will occur.

## Useful Formula

### 1 Calculating the Tank Spray Area

Use this formula to calculate the area each tank full of spray will cover.

**Area Covered (ha) =**

$$\frac{\text{Tank Volume (litres)}}{\text{Spray Application Rate (l/ha)}}$$

$$\begin{aligned} \text{eg, } & \frac{250}{100} \\ & = 2.5 \text{ hectares.} \end{aligned}$$

### 2 Calculating the Total Liquid Volume Required

Use this formula to calculate the amount of spray liquid required to spray a given area.

**Total Liquid Volume Required (litres) =**  
**Area (ha) x Spray Application Rate (l/ha)**

$$\begin{aligned} \text{eg, } & 2 \times 100 \\ & = 200 \text{ litres.} \end{aligned}$$



*Remove the tank drain plug.*



*Check & clean the suction filter.*



*Remove & clean the suction line filter, then reassemble.*

## Clean & Flush the CropPak

The CropPak sprayer should be thoroughly cleaned and flushed:

- Between chemical changes, and
- At the end of each day's spraying.

To completely flush and clean the sprayer:

- 1 Remove the tank drain plug to drain spray mixture from the tank.

Ensure drained mixture is disposed of as required by law. Read the chemical instructions.



### CAUTION

**Always ensure the site for flushing and cleaning the sprayer meets with environmental and statutory regulations**



### CAUTION

**If you experience heavy frosts in you area, run the pump until the spray lines are dry after use. This will prevent damage from water freezing in the spray lines and pump.**

- 2 After chemicals have drained from the main tank, thoroughly rinse out the tank.
- 3 Remove and thoroughly clean the suction line filter & reassemble.
- 4 Close the tank drain valve and add clean water to the tank to thoroughly flush the lines, pump and spray gun (& boom if fitted).
- 5 Switch On the pump.
- 6 Hold down the hand grip lever until all mixture is flushed out of the hose and hand gun.
- 7 On completion of flushing, release the trigger of the hand gun and turn the power switch Off.
- 8 Repeat steps 1 to 7 to more completely remove chemical residue from the tank and sprayer system.
- 9 Wash/hose down the outside of the sprayer.



## Using Tank & Equipment Cleaners

If a cleaning agent is required (refer to chemical label), first completely flush the Sprayer with water as outlined on the previous page.

To use the tank & equipment cleaner:

- 1 Fill the spray tank approximately half full of fresh water.
- 2 Add cleaning agent (use according to the manufacturer's instructions).
- 3 Switch on the pump.
- 4 Place the lance into the tank and hold down the hand grip lever to circulate cleaning fluid through the suction line, pressure line, hand gun and back to the tank.
- 5 If you require the cleaning agent to soak or stand for a period, shut off the hand gun by releasing the hand grip lever and switch the power off.
- 6 When soaking is completed, start the sprayer following steps 3 & 4 to flush the suction lines, pressure lines and hand gun.
- 7 Stop flushing by releasing the hand grip lever and then switch the power off.
- 8 Remove the spray tank drain plug and allow cleaning mixture to drain from the tank.
- 9 Again completely flush the sprayer with fresh water as outlined on the previous page.
- 10 Check the filter to ensure scale deposits are removed from the filter if they are present. Often the cleaning agent will dislodge chemical build-up from spray lines and fittings.

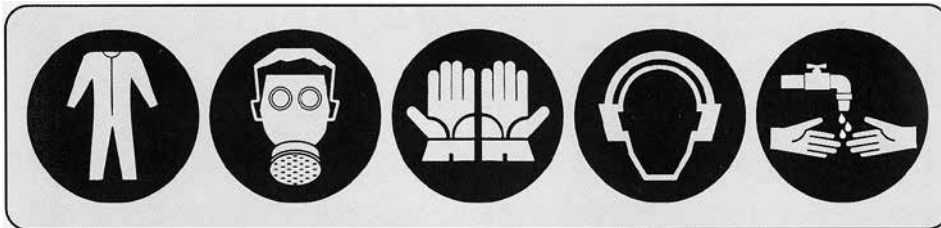
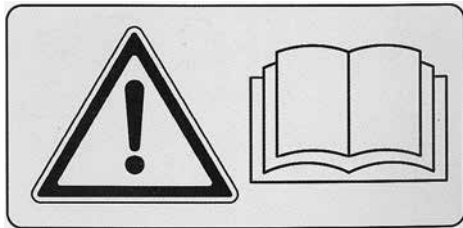

## Safe Sprayer Operation

- Always read your sprayer operator's manual thoroughly before operating.
- Dispose of all chemical containers as per instructions on label. Failure to do so could result in contaminating the environment with chemicals.
- Inspect hose and hose connections daily. Always wear rubber gloves when tightening connections. Damaged, loose or worn hoses could result in operator being exposed to toxic chemicals which could result in serious illness or faulty sprayer operation.



## WARNING

Accidents occur every year due to careless use of farm machinery and farm chemicals.

You can avoid these hazards by reading and following the instructions in this operator's manual and observing operating safety.

- Follow the chemical manufacturer's precautions before cleaning the sprayer. Exposure to chemicals could result in serious illness or death.
- Always use the proper application rate. To assure proper application rate calibrate sprayer frequently. The wrong application rate of a pesticide which is too high may expose the operator and the environment to danger.
- Always wear gloves and wash the sprayer before doing any disassembly repair work. Chemical residues on the sprayer parts could contaminate operator or service personnel causing serious illness.
- Always relieve system pressure before doing any work on the machine. Disconnecting components while under pressure will result in uncontrolled spray discharge which may be hazardous to humans. Failure to do so could cause operator to be exposed to high pressure spray of chemical resulting in serious injury or machine damage.
- Check the entire sprayer, prior to each use, for any loose connections.
- Use only genuine Croplands parts for any necessary replacement. Home made parts may look the same but might be dangerous in operation.
- Do not disconnect any hoses nozzles or filters while sprayer is operating.
- Always clean the sprayer before doing any repairs.



**Trouble Shooting Pump Problems**

**42**

PROBLEM	PROBABLE CAUSE	REMEDY
<b>A. Failure to Prime</b> - motor operates, but no pump discharge.	1) Restriction in intake or discharge line. 2) Air leak in intake line. 3) Punctured pump diaphragm. 4) Defective pump check valve. 5) Crack in pump housing. 6) Debris in filter or check valve.	1) Open all line valves, check for “jammed” check valve poppets & clean clogged lines. 2) Fix air leak in intake line. 3) Replace pump diaphragm. 4) Repair or replace pump check valve. 5) Replace pump housing. 6) Clean filter or check valve.
<b>B. Motor Fails to Turn On</b>	1) Pump motor not electrically connected. 2) Fuse blown. 3) Loose wiring or connection. 4) Pressure switch failure. 5) Defective motor or rectifier. 6) Frozen cam-bearing.	1) Make electrical connection. 2) Replace fuse. 3) Repair loose wiring or connection. 4) Replace pressure switch. 5) Replace motor or rectifier. 6) Repair or replace cam-bearing.
<b>C. Pump Fails to Turn Off</b>	1) Faulty pressure switch.	1) Replace faulty pressure switch.
<b>D. Low Flow and Pressure</b>	1) Blocked suction filter. 2) Air leak at pump intake. 3) Accumulation of debris inside pump & plumbing. 4) Worn pump bearing (excessive noise). 5) Punctured pump diaphragm. 6) Defective rectifier or motor. 7) Insufficient voltage to pump.	1) Clean the suction filter. 2) Repair air leak on the pump intake. 3) Clean the inside of the pump and plumbing. 4) Replace pump bearing. 5) Replace pump diaphragm. 6) Replace rectifier or motor. 7) Correct voltage to pump.
<b>E. Pulsating Flow</b> - Pump Cycling On and Off.	1) Restricted pump delivery. 2) Nozzle too small.	1) Check discharge lines, fittings, valves & spray nozzles for clogging or undersizing. 2) Ensure nozzle is correct size.

<b>US30A</b>	<b>44</b>
<b>US60A &amp;US100A</b>	<b>45</b>
<b>US100A/15</b>	<b>46</b>
<b>US200, US200B Models</b>	<b>47</b>
<b>UM70 Models</b>	<b>48</b>
<b>UW50 Models</b>	<b>49</b>
<b>Pumps</b>	<b>50</b>
<b>Accessories &amp; Parts</b>	<b>51</b>

**ALL SPARE PARTS INFORMATION is now listed on the Croplands website:**

- Go to [www.croplands.com.au](http://www.croplands.com.au)
- Search in the Parts Information section on the landing page.
- Type in the model of your CropPak and download the current parts information.

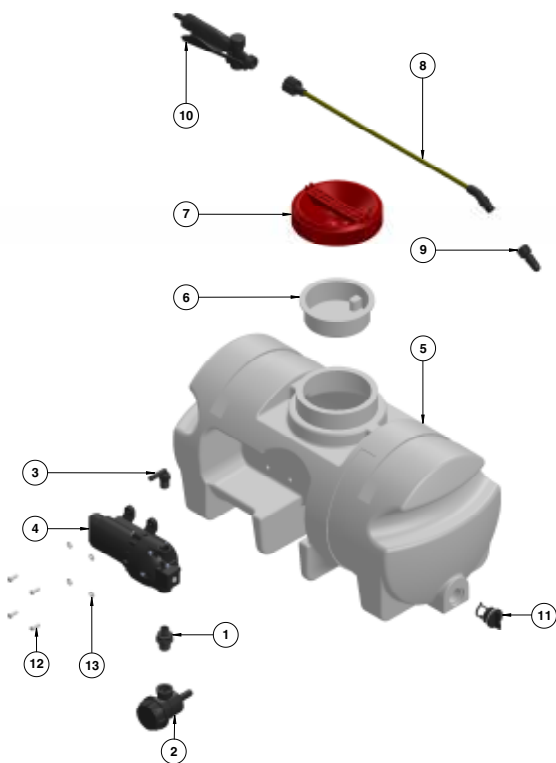

Item	Part Number	US30A Parts Description	Qty
1	A2402021	NIPPLE 1/2" - 3/8" REDUCING	1
2	A309953	FILTER 1/2" BLACK PP 50MESH	1
3	BJHB038-90	ELBOW 3/8" NPT X 3/8" BARB	1
4	FL3501-506	PUMP TRIPLEX 7.6LPM 50PSI NO SWITCH	1
5	P30D-RAW	TANK 30LT POLY UTEPAK	1
6	SW501-004	LID STRAINER	1
7	SW502-001C	TANK LID ASSEMBLY RED	1
8	SW803-085	BRASS LANCE 52CM CURVED	1
9	SW803-262C	ADJ PLASTIC NOZZLE & CAP NUT	1
10	SW808-073-C	SHUT OFF VALVE F/ 3/8" ID HOSE	1
11	UP-416	BOAT PLUG	1
12	UP-501	S BEND HOSE EPDM BLACK	1
13	M6X16	M6 X 16 BOLT HT ZP	4
14	M6FWASHER	M6 FLAT WASHER ZP	4
n/a	HPW10	HOSE	6
n/a	COBRAC18-19/8	CLAMP	2
n/a	TR38HC	CLAMP	3
n/a	UP-119B	SWITCH KIT	1
n/a	GP-OMCP12-B	MANUAL	1

NOTE

**This parts list is indicative of this model sprayer.**  
**For further parts information refer to**  
**[www.croplands.com.au](http://www.croplands.com.au)**

## NOTE

This parts list is indicative of this model sprayer.  
For further parts information refer to  
[www.croplands.com.au](http://www.croplands.com.au)

Item	Part Number	US60 Parts Description	Qty	Item	Part Number	US100A Parts Description	Qty
1	A2402021	NIPPLE 1/2" - 3/8" REDUCING	1	1	A2402021	NIPPLE 1/2" - 3/8" REDUCING	1
2	A309953	FILTER 1/2" BLACK PP 50MESH	1	2	A309953	FILTER 1/2" BLACK PP 50MESH	1
3	BJHB038-90	ELBOW 3/8" NPT X 3/8" BARB	1	3	BJHB038-90	ELBOW 3/8" NPT X 3/8" BARB	1
4	FL3501-506	PUMP TRIPLEX 7.6LPM 50PSI NO SWITCH	1	4	FL3501-506	PUMP TRIPLEX 7.6LPM 50PSI NO SWITCH	1
5	P60B-RAW	TANK 60LT UTEPAK W/O FITTING	1	5	P100D-RAW	TANK 100LT POLY UTEPAK W/O FITTING	1
6	SW501-004	LID STRAINER	1	6	SW501-004	LID STRAINER	1
7	SW502-001C	TANK LID ASSEMBLY RED	1	7	SW502-001C	TANK LID ASSEMBLY RED	1
8	SW803-085	BRASS LANCE 52CM CURVED	1	8	SW803-085	BRASS LANCE 52CM CURVED	1
9	SW803-262C	ADJ PLASTIC NOZZLE & CAP NUT	1	9	SW803-262C	ADJ PLASTIC NOZZLE & CAP NUT	1
10	SW808-073-C	SHUT OFF VALVE F/ 3/8" ID HOSE	1	10	SW808-073-C	SHUT OFF VALVE F/ 3/8" ID HOSE	1
11	UP-416	BOAT PLUG	1	11	UP-416	BOAT PLUG	1
12	UP-501	S BEND HOSE EPDM BLACK	1	12	UP-501	S BEND HOSE EPDM BLACK	1
13	M6X16	M6 X 16 BOLT HT ZP	4	13	M6X16	M6 X 16 BOLT HT ZP	4
14	M6FWASHER	M6 FLAT WASHER ZP	4	14	M6FWASHER	M6 FLAT WASHER ZP	4
n/a	HPW10	HOSE	6	n/a	COBRAC18-19/8	CLAMP	2
n/a	COBRAC18-19/8	CLAMP	2	n/a	TR38HC	CLAMP	3
n/a	TR38HC	CLAMP	3	n/a	UP-119B	SWITCH KIT	1
n/a	UP-119B	SWITCH KIT	1	n/a	GP-OMCP12-B	MANUAL	1
n/a	GP-OMCP12-B	MANUAL	1				

**NOTE**

**This parts list is indicative of this model sprayer.  
For further parts information refer to  
[www.croplands.com.au](http://www.croplands.com.au)**

Item	Part Number	US100A/15 Parts Description	Qty
1	A200020	FLY NUT 1/2" 12.5 MMD	1
2	A309953	FILTER 1/2" BLACK PP 50MESH	1
3	A908006	GAUGE 40MM 0-6 BAR	1
4	A9620050	PRV 1/2" FAST COUPLING	1
5	AG4000B	FLAT SEAL 5/8" EPDM	1
6	B163.604.4	ELBOW 10MM 90DEG C/W 1/2" WING NUT	1
7	COBRAC18-19/8	COBRAC CLAMP 1/2" BLACK HOSE	2
8	CP8027-1-NYB	CAP NYLON LONG	1
9	FL20381-000	KIT 1/2" THREAD STRAIGHT PAIR	1
10	FL3521-139	PUMP 12V 60PSI-15.1LT SANTO-VITON	1
11	P100D-RAW	TANK 100LT POLY UTEPAK W/O FITTING	1
12	SW501-004	LID STRAINER	1
13	SW502-001C	TANK LID ASSEMBLY RED	1
14	SW803-085	BRASS LANCE 52CM CURVED	1
15	SW803-262C	ADJ PLASTIC NOZZLE & CAP NUT	1
16	SW808-073-C	SHUT OFF VALVE F/ 3/8" ID HOSE	1
17	UP-416	BOAT PLUG	1
18	UP-501	S BEND HOSE EPDM BLACK	1
19	TR38HC	HOSE CLAMP 10MM 3/8" WORM DRIVE	2
20	8121-NYB-540TD	ELBOW SHANK NYLON 11/16"M-1/2"	1
21	8400-500-NYB	CAP HOSE SHANK 1/2" HOSE NYLON	1
22	M6X16	M6 X 16 BOLT HT ZP	4
23	M6FWASHER	M6 FLAT WASHER ZP	4
n/a	TR12HC	HOSE CLAMP 10MM 3/8" WORM DRIVE	2
n/a	HPW10	HOSE	6
n/a	HPW12	HOSE	1
n/a	UP-119B	SWITCH KIT	1
n/a	GP-OMCP12-B	MANUAL	1



Item	Part Number	US200 Parts Description	Qty
	P200B-RAW	RAWTANK	1
	FL3501-506	PUMP	1
	A205020	BACKNUT	2
	AG40002	FLATSEAL	1
	COBRAC18-19/8	CLAMP	2
	A2402021	REDNIPPLE	1
	HPW10	HOSE	6
	SW808-073C	VALVE	1
	SW803-262C	JET	1
	SW803-085	LANCE	1
	HPW12	HOSE	1
	COBRAC15/8	CLAMP	2
	SW501-004	STRAINER	1
	UP-169	PIPE	1
	SW502-001C	LID	1
	UP-175	HOOK	4
	UP-416	PLUG	1
	B163.604.13	ELBOW	1
	BJHB038-90	ELBOW	1
	A309953	FILTER	1
	UP-119B	SWITCH KIT	1
	GP-OMCP12-B	MANUAL	1

## NOTE

This parts list is indicative of the 200, 400 & 800 sprayers.

For further parts information refer to  
[www.croplands.com.au](http://www.croplands.com.au)



Item	Part Number	US70 Parts Description	Qty
	P70M-RAW	RAWTANK	1
	FL3501-506	PUMP	1
	8121-NYB-540TD	ELBOW	1
	8400-406-NYB	CAP	1
	AG4000B	FLATSEAL	1
	COBRAC15/8	CLAMP	4
	CP8027-NYB	CAP	1
	HPW10	HOSE	4
	SW501-004	STRAINER	1
	SW502-001C	LID	1
	SW803-085	LANCE	1
	SW803-262C	JET	1
	SW808-073C	VALVE	1
	UP-108	BOXLID	1
	UP-123	STRAP	1
	8079-PP-50	STRAINER	1
	BJHB038-90	ELBOW	2
	UP-119B	SWITCH KIT	1
	GP-OMCP12-B	MANUAL	1

**NOTE**

This parts list is indicative of this model sprayer.  
For further parts information refer to  
[www.croplands.com.au](http://www.croplands.com.au)





**NOTE**

For further parts information refer to  
[www.croplands.com.au](http://www.croplands.com.au)

**Flojet FL3501-506**



**Shurflo SHU5059-3611-D011**



**Flojet FL3521-139**



**Shurflo SHU8000-547-189**



## NOTE

For the latest pump drawings and specifications see the Croplands Web site and go to the Sprayer Components section.

Pic	Order code	Description
A	SW219-117	Small spray guard, 22cm
B	SW219-099	Large spray guard, 40cm
C	SW-LANCE-P-ASSY	Gun & lance (plastic) assembly c/w 10mm tail
D	SW219-236C	Telescopic lance 94cm c/w adjustable nozzle
E	SW219-142C	Spray lance 100cm (plastic) c/w adjustable nozzle
F	SW219-143C	Spray lance 150cm (plastic) c/w adjustable nozzle
G	SW219-146C	Spray lance 200cm (plastic) c/w adjustable nozzle
H	SW219-282C	4-Nozzle boom 150cm (plastic)
I	SW219-151C	3-Nozzle boom 150cm (plastic)
J	SW219-138C	3-Nozzle boom 100cm (plastic)
K	SW219-148C	2-Nozzle boom 75cm (plastic)
L	SW219-140C	2-Nozzle boom 50cm (plastic)
M	SW219-147C	Double U Nozzle complete w/- caps
N	SW803-262C	Adjustable poly nozzle



Above: Swivel Nozzle for all CropPak Sprayers  
Part No: SW803-262C (Plastic)  
SW219-089C (Brass)

Left: Lance Hand Grip for all CropPak Sprayers  
Part No: SW808-073C



Above: Swissmex Lance, 52cm, brass. For all CropPak Sprayers  
Part No: SW803-085



---

Croplands Customer Service

**Australia**

Freecall: 1800 999 162

Freefax: 1800 623 778

[sales@croplands.com.au](mailto:sales@croplands.com.au)

[www.croplands.com.au](http://www.croplands.com.au)

Croplands Customer Service

**New Zealand**

Freecall: 1800 106 898

Freefax: 1800 117 711

[sales@croplands.co.nz](mailto:sales@croplands.co.nz)

[www.croplands.co.nz](http://www.croplands.co.nz)